

CATCM901



Ignition Coils  
Bobines  
Bobinas de Encendido  
Bobines  
Zündspulen  
Катушки зажигания

2009-2010



 **FEDERAL  
MOGUL**

 [www.fmecat.eu](http://www.fmecat.eu)



**Pimp your performance.**  
**Iridium**



**Certificate according to BER 1400/2002,  
Art. 1 (t), (u)**

We hereby certify that the Federal-Mogul products sold in the European Aftermarket under the brands AE<sup>®</sup>, ABEX<sup>®</sup>, BERAL<sup>®</sup>, CHAMPION<sup>®</sup>, DURON<sup>®</sup>, FERODO<sup>®</sup>, FP DIESEL<sup>®</sup>, GLYCO<sup>®</sup>, GOETZE<sup>®</sup>, MOOG<sup>®</sup>, NECTO<sup>®</sup>, NÜRAL<sup>®</sup>, PAYEN<sup>®</sup>, fulfil the quality requirements applicable to the use of spare parts for repair or maintenance of motor vehicles by authorised repairers, as defined in Art. 1. (1) (t), (u) of the Block Exemption Regulation (EC) 1400/2002.

Date: 27/01/2009



Martin Hendricks  
Vice President EMEA  
Global Aftermarket  
Federal-Mogul Corporation



# Terms of Business

## GB - IMPORTANT

Reproduction of this catalogue or parts thereof is only allowed with our explicit permission in writing. Pictorial representations and design are copyrighted. Claims for damages, of any form whatsoever, resulting from details made in this catalogue or from incorrect use, application, storage or handling, are explicitly excluded. Contractual rights and any resulting or related claims based thereon, irrespective of form, initially come into being on the basis of a separate written agreement, in particular on the basis of our general terms of sale and delivery.

All former statements lose their validity with the publication of this catalogue.

The catalogue is not an operating manual for the use and installation of the ignition coils. It does not contain any advice in a legal sense. The catalogue neither replaces the constantly applicable technical regulations - particularly for tolerances - nor the installation and maintenance stipulations of the individual engine manufacturer.

Also, it is not possible to forego the expertise of those carrying out the installation and application. The individual references made in this catalogue for the installation and the application of the ignition coils are instructions solely for the technically qualified specialist and are to be checked and verified by them for their suitability in each case. Federal-Mogul accepts no responsibility for application decisions.

The contents of the catalogue are not intended to create or substitute any contractual agreement which has to be reserved exclusively to a separate agreement between 2 identified parties, whereby seller can be only one of our Federal-Mogul entities as mentioned on the back cover page.

The right is retained to correct errors and alterations, particularly with regard to amendments in the engine manufacturer's details and stipulations.

## F - IMPORTANT

La reproduction de ce catalogue, même partielle, n'est autorisée qu'avec notre accord préalable et par écrit. Les illustrations graphiques et la présentation font l'objet d'un copyright. Nous excluons toutes réclamations ayant pour objet ce catalogue ou pouvant résulter de son incompréhension, portant sur de mauvaises utilisations, manipulations, manutentions ou mauvais stockage. Des droits contractuels et des droits dérivés, de quelque nature qu'ils soient, ne peuvent résulter que d'un accord écrit, particulièrement sur la base de nos conditions générales de ventes et de livraisons.

Ce catalogue annule et remplace toute édition antérieure.

Le catalogue n'est pas une notice d'utilisation et de montage des bobines. Il ne contient pas de directives en tant que telles. Le catalogue ne remplace ni les prescriptions techniques, toujours prioritaires, particulièrement pour les tolérances, ni les prescriptions de montage et d'entretien des constructeurs des moteurs figurant dans ce catalogue. Il ne peut en aucun cas remplacer les connaissances professionnelles nécessaires pour le montage et l'utilisation. Les remarques données pour le montage et l'utilisation des bobines sont exclusivement destinées au professionnel averti et de formation technique, à qui il appartiendra de vérifier la conformité des indications pour chaque cas. La responsabilité des décisions d'utilisation ne peut être prise en charge par Federal-Mogul.

Le contenu de ce catalogue ne peut constituer ou remplacer un contrat qui doit faire l'objet d'un document séparé établi entre 2 parties, dont l'une doit être une entité légale de Federal-Mogul dont la liste figure sur la couverture arrière.

Nous nous réservons le droit d'apporter toutes corrections d'erreurs et modifications, suite notamment à de nouvelles données fournies par les constructeurs.

## E - IMPORTANTE

Queda totalmente prohibida la reproducción, total o parcial, del contenido de este catálogo, salvo previa autorización nuestra, realizada por escrito. Están, asimismo, reservados todos los derechos sobre el diseño y presentación del catálogo. No se aceptará ningún tipo de reclamación que esté basada en la interpretación de los datos contenidos en este catálogo, así como en el incorrecto uso, manipulación o almacenaje de nuestras piezas. Únicamente se aceptarán reclamaciones que estén basadas en derechos contractuales o en los motivos arriba indicados, siempre que exista un acuerdo especial y por escrito basado en nuestras condiciones generales de venta y suministro.

Con la edición de este catálogo queda anulada toda la información contenida en catálogos anteriores.

El catálogo no es un manual para el uso e instalación de los bobinas de encendido, y no representa una asesoría técnica, en el sentido legal. Los datos del catálogo no sustituyen, en ningún caso, a las especificaciones técnicas, tanto en lo que se refiere a tolerancias como a las instrucciones de instalación y mantenimiento, indicadas por los fabricantes de los motores, especificaciones que serán siempre prioritarias. Se entiende que el uso y montaje de estas piezas está encomendado a personal debidamente cualificado. Las indicaciones sobre uso y montaje de los bobinas de encendido contenidas en este catálogo, están exclusivamente dirigidas a profesionales con la debida capacitación y formación técnica, que deben decidir en cada caso sobre la exactitud de las mismas. La responsabilidad de estas decisiones no puede ser, en ningún caso, achacada a Federal-Mogul.

La información facilitada en el catálogo no representa o sustituye ningún tipo de acuerdo, quedando a tal efecto, el acuerdo por separado entre dos partes donde sólo entidades de Federal-Mogul, pueden ser identificadas como la parte vendedora como se menciona en la contraportada. Los datos e instrucciones contenidos en este catálogo podrán ser corregidos o modificados sin previo aviso.

## I - IMPORTANTE

La riproduzione di questo catalogo, anche parziale, e' permessa soltanto in seguito ad una autorizzazione scritta. I grafici ed i disegni sono marchio depositato. Reclami per difetti, di qualsiasi natura essi siano, relativi al contenuto di questo catalogo, o all'uso improprio di esso, verranno respinti. Le pretese avanzate od i reclami dovranno essere in conformita' con le nostre condizioni generali di vendita.

Il presente catalogo annulla e sostituisce tutte le edizioni precedenti.

Il catalogo non e' un manuale per l'utilizzo ed il montaggio delle bobine. Non contiene indicazioni in questo senso. Esso non sostituisce le descrizioni tecniche, sempre prioritarie, in particolare per le tolleranze, ne' le istruzioni relative al montaggio ed alla manutenzione date dai costruttori dei rispettivi motori. Non puo' in nessun caso essere paragonato alla conoscenza professionale necessaria per il montaggio e l'utilizzo. Le considerazioni sul montaggio delle bobine, fatte su questo catalogo, sono destinate esclusivamente a professionisti con formazione tecnica i quali verificheranno l'esattezza della informazioni, in ogni caso.

Le responsabilita' derivanti dall'utilizzo improprio dello stesso non potranno essere addebitate alla Federal-Mogul.

I contenuti del catalogo non sostituiscono in alcun modo gli accordi contrattuali che sono riservati esclusivamente a due contraenti definiti; come venditore si intende una delle societa' Federal Mogul menzionate sul retro del catalogo.

Ci riserviamo di apportare correzioni e modifiche, relative, in particolare, a dati o istruzioni ricevute dal costruttore del motore.

## D - WICHTIGE HINWEISE

Nachdruck, auch auszugsweise, ist nur mit unserer ausdrücklichen schriftlichen Zustimmung gestattet. Die bildlichen Darstellungen und Ausstattungen sind geschützt. Ersatzansprüche, gleich welcher Art, aufgrund der Angaben in diesem Katalog oder auf Grund unsachgemäßem Umgang, unsachgemäßer Verwendung, Lagerung oder Handhabung der angebotenen Produkte, sind ausdrücklich ausgeschlossen. Vertragliche Ansprüche und daraus abgeleitete oder darauf beruhende Ansprüche, gleich welcher Art, kommen erst auf Grund einer besonderen schriftlichen Vereinbarung, insbesondere auf der Grundlage unserer allgemeinen Verkaufs- und Lieferbedingungen, zustande.

Der Katalog ist keine Einbauanleitung für Zündspulen.

Er enthält keine Beratung im Rechtssinne. Der Katalog ersetzt weder die immer vorrangigen technischen Vorschriften, insbesondere für Toleranzen, sowie die Einbau- und Wartungsvorschriften des jeweiligen Motorenherstellers, noch kann auf das notwendige Fachwissen des die Montage und die Verwendung Durchführenden verzichtet werden. Die in diesem Katalog jeweils gegebenen Hinweise für Einbau und Verwendung der Zündspulen sind Hinweise ausschließlich für den technisch ausgebildeten und versierten Fachmann, die von ihm im jeweiligen Anwendungsfall auf ihre Eignung geprüft und entschieden werden müssen. Eine Haftung wird von Federal-Mogul für Anwendungsentscheidungen nicht übernommen.

Die Inhalte dieses Katalogs sind nicht dazu bestimmt eine vertragliche Verpflichtung zu begründen oder zu ersetzen, was ausschliesslich einer gesonderten Vereinbarung zwischen 2 konkret bezeichneten Parteien vorbehalten bleibt, wobei der Verkäufer eine unserer Federal-Mogul Gesellschaften sein wird, wie auf der Rückseite des Kataloges.

Die Korrektur von Irrtümern und Änderungen, insbesondere auf Grund von geänderten Angaben und Vorschriften der Motorenhersteller, bleibt vorbehalten.

## RU - ВАЖНО

Воспроизводство этого каталога или ее частей позволено только с нашим явным разрешением в письменной форме. Иллюстрированные представления и дизайн защищены авторским правом.

Требования о возмещении ущерба, любой формы, исходя из деталей в этом каталоге или от неправильного использования, хранения или обращение, явно исключены. Договорные права и любые связанные требования базировались вслед за тем, независимо от формы, отдельного первоначально письменного соглашения, в особенности на основе наших общих условий продаж и поставок.

Все прежние утверждения теряют свою юридическую силу с публикацией данного каталога.

Каталог не операционное руководство для использования и установки катушек зажигания. Оно не содержит совета в юридическом смысле. Каталог не заменяет постоянно применимые технические инструкции - особенно при допусках - соглашения установки и обслуживания отдельного автопроизводителей. Кроме того, не возможно предсказать профессионализм тех, кто выполняют установку и ремонт. Отдельные ссылки, сделанные в этом каталоге для установки и замены катушек зажигания, являются инструкциями исключительно для технически компетентного специалиста и должны быть проверены и проверены ими для их пригодности в каждом случае. Federal-Mogul не несет ответственность за ремонтные работы.

Содержание каталога не предназначено, чтобы создавать или заменять любые договорные соглашения, которое должны быть сохранены исключительно к отдельному соглашению между 2мя сторонами, посредством чего продавец может быть только одним из юридических лиц Federal-Mogul как упомянуто на странице обратной стороны.

Право Сохраняется право, исправлять ошибки и изменения, особенно относительно к поправкам по деталям изготовителей двигателя и их условиям.

The European car park consists of **230.000 different vehicle types**.  
 The average European car consists of about **2.000 different parts**.

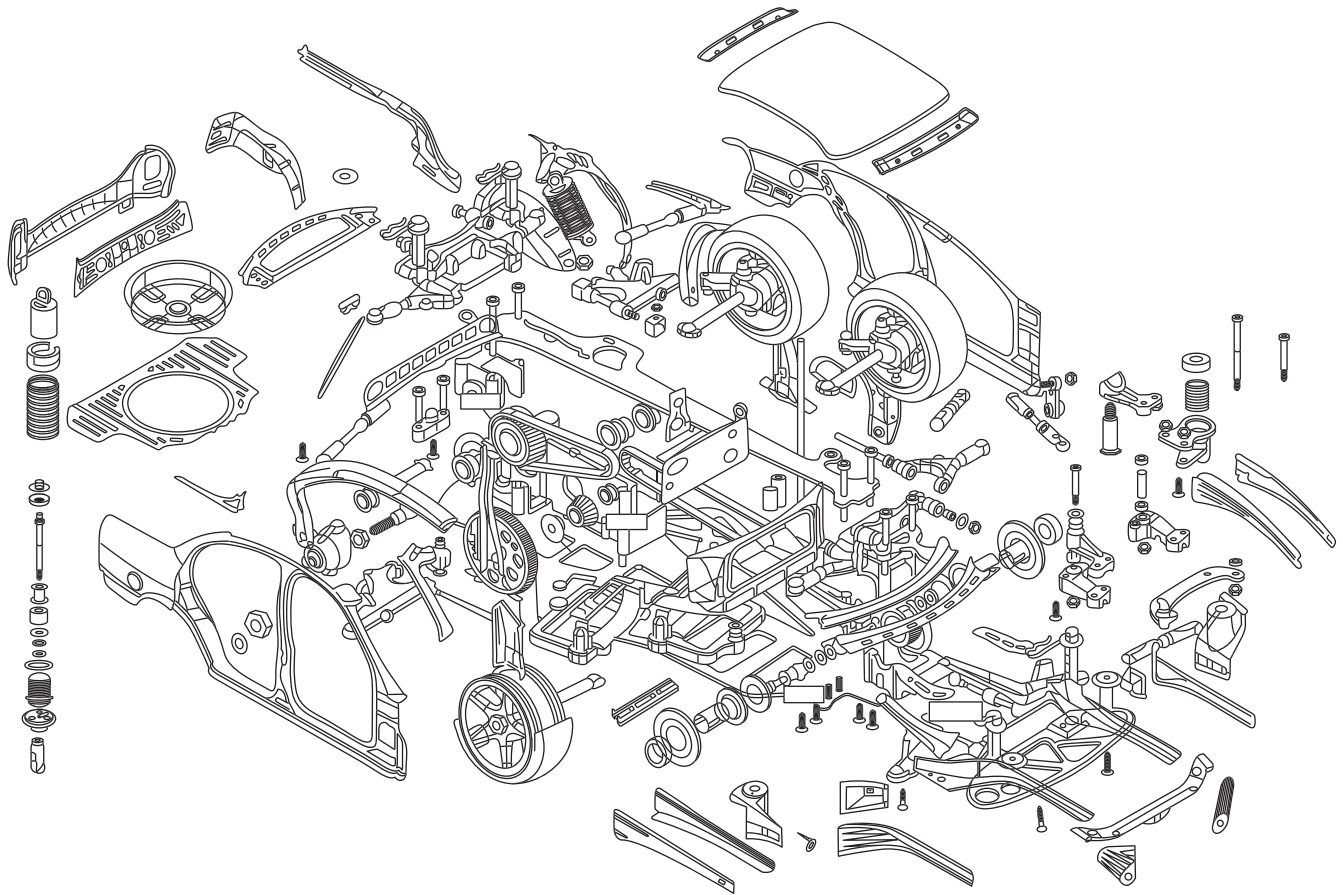

For the most common service tasks, you now only need **77 parts**.



**New Contact**

50 references cover 90% of all popular applications.



**New Eon**

10 references cover 95% of all popular applications.



**New Flomax**

17 references cover 90% of all popular applications.

The Champion Compact Range fits almost every car.



[www.fmecat.eu](http://www.fmecat.eu)  
[www.federalmogul.com](http://www.federalmogul.com)





|  |           |
|--|-----------|
|  | <b>2</b>  |
|  | <b>24</b> |
|  | <b>26</b> |
|  | <b>31</b> |



kW / BHP



Amp

Out  
kVOut  
mJ**ALFA ROMEO****33 (907A)**

|                             |   |    |                    |       |             |         |     |    |    |
|-----------------------------|---|----|--------------------|-------|-------------|---------|-----|----|----|
| 1.4 4x4                     | 4 | 8V | AR 30755           | 66/90 | 06/91→09/94 | BAE800B | 6.3 | 25 | 40 |
| 1.4 i.e. (907.A3A, 907.A3B) | 4 | 8V | AR 30755, AR 30753 | 65/88 | 06/91→09/94 | BAE800B | 6.3 | 25 | 40 |
| 1.4 i.e. (907.A3A, 907.A3B) | 4 | 8V | AR 30755, AR 30753 | 66/90 | 06/91→09/94 | BAE800B | 6.3 | 25 | 40 |

**33 Sport Wagon (907B)**

|              |   |    |                    |       |             |         |     |    |    |
|--------------|---|----|--------------------|-------|-------------|---------|-----|----|----|
| 1.4 i.e.     | 4 | 8V | AR 30755           | 65/88 | 06/91→09/94 | BAE800B | 6.3 | 25 | 40 |
| 1.4 i.e.     | 4 | 8V | AR 30755           | 66/90 | 06/91→09/94 | BAE800B | 6.3 | 25 | 40 |
| 1.4 i.e. 4x4 | 4 | 8V | AR 30587, AR 30755 | 66/90 | 06/91→09/94 | BAE800B | 6.3 | 25 | 40 |

**145 (930)**

|          |   |    |          |       |             |         |     |    |    |
|----------|---|----|----------|-------|-------------|---------|-----|----|----|
| 1.4 i.e. | 4 | 8V | AR 33501 | 66/90 | 07/94→12/96 | BAE800B | 6.3 | 25 | 40 |
|----------|---|----|----------|-------|-------------|---------|-----|----|----|

**146 (930)**

|          |   |    |          |       |             |         |     |    |    |
|----------|---|----|----------|-------|-------------|---------|-----|----|----|
| 1.4 i.e. | 4 | 8V | AR 33501 | 66/90 | 12/94→12/96 | BAE800B | 6.3 | 25 | 40 |
|----------|---|----|----------|-------|-------------|---------|-----|----|----|

**155 (167)**

|                  |   |     |          |         |             |         |     |    |    |
|------------------|---|-----|----------|---------|-------------|---------|-----|----|----|
| 2.0 16V Turbo Q4 | 4 | 16V | AR 67203 | 137/186 | 01/92→12/97 | BAE800B | 6.3 | 25 | 40 |
| 2.0 16V Turbo Q4 | 4 | 16V | AR 67203 | 140/190 | 01/92→12/97 | BAE800B | 6.3 | 25 | 40 |

**MITO**

|     |   |    |  |       |        |         |     |    |    |
|-----|---|----|--|-------|--------|---------|-----|----|----|
| 1.4 | 4 | 8V |  | 57/78 | 09/08→ | BAE403C | 7.5 | 27 | 42 |
|-----|---|----|--|-------|--------|---------|-----|----|----|

**AUDI****80 (8C, B4)**

|               |   |    |     |   |        |             |          |     |    |    |
|---------------|---|----|-----|---|--------|-------------|----------|-----|----|----|
| 1.6           | 4 | 8V | ABM | ✓ | 52/71  | 09/91→12/94 | BAE851AE | 6.5 | 28 | 85 |
| 2.0           | 4 | 8V | ABT | ✓ | 66/90  | 09/91→12/94 | BAE851AE | 6.5 | 28 | 85 |
| 2.0 E         | 4 | 8V | ABK | ✓ | 85/115 | 09/91→12/94 | BAE851AE | 6.5 | 28 | 85 |
| 2.0 E quattro | 4 | 8V | ABK | ✓ | 85/115 | 09/91→12/94 | BAE851AE | 6.5 | 28 | 85 |

**80 Avant (8C, B4)**

|       |   |    |     |   |        |             |          |     |    |    |
|-------|---|----|-----|---|--------|-------------|----------|-----|----|----|
| 2.0   | 4 | 8V | ABT | ✓ | 66/90  | 07/92→01/96 | BAE851AE | 6.5 | 28 | 85 |
| 2.0 E | 4 | 8V | ABK | ✓ | 85/115 | 07/92→01/96 | BAE851AE | 6.5 | 28 | 85 |

**100 (4A, C4)**

|     |   |    |     |   |        |             |          |     |    |    |
|-----|---|----|-----|---|--------|-------------|----------|-----|----|----|
| 2.0 | 4 | 8V | AAE | ✓ | 74/101 | 12/90→06/94 | BAE851AE | 6.5 | 28 | 85 |
|-----|---|----|-----|---|--------|-------------|----------|-----|----|----|

**100 Avant (4A, C4)**

|       |   |    |     |   |        |             |          |     |    |    |
|-------|---|----|-----|---|--------|-------------|----------|-----|----|----|
| 2.0 E | 4 | 8V | AAE | ✓ | 74/101 | 09/91→06/94 | BAE851AE | 6.5 | 28 | 85 |
|-------|---|----|-----|---|--------|-------------|----------|-----|----|----|

**A2 (8Z0)**

|         |   |     |     |  |        |        |          |      |    |    |
|---------|---|-----|-----|--|--------|--------|----------|------|----|----|
| 1.4     | 4 | 16V | AUA |  | 55/75  | 02/00→ | BAE907AE | 7.5  | 33 | 85 |
| 1.4     | 4 | 16V | BBY |  | 55/75  | 02/00→ | BAE408AE | 15.0 | 30 | 52 |
| 1.6 FSI | 4 | 16V | BAD |  | 81/110 | 05/02→ | BAE408AE | 15.0 | 30 | 52 |

**A3 (8L1)**

|             |   |     |               |  |        |             |          |     |    |    |
|-------------|---|-----|---------------|--|--------|-------------|----------|-----|----|----|
| 1.6         | 4 | 8V  | AEH, AKL, APF |  | 74/101 | 09/96→08/00 | BAE907AE | 7.5 | 33 | 85 |
| 1.6         | 4 | 8V  | AVU, BFQ      |  | 75/102 | 08/00→      | BAE907AE | 7.5 | 33 | 85 |
| 1.8         | 4 | 20V | AGN, APG      |  | 92/125 | 09/96→      | BAE907AE | 7.5 | 33 | 85 |
| 1.8 quattro | 4 | 20V | AGN           |  | 92/125 | 08/98→      | BAE907AE | 7.5 | 33 | 85 |

**A3 (8P1)**

|         |   |     |          |  |        |        |          |      |    |    |
|---------|---|-----|----------|--|--------|--------|----------|------|----|----|
| 1.6     | 4 | 8V  | BGU      |  | 75/102 | 05/03→ | BAE907AE | 7.5  | 33 | 85 |
| 1.6 FSI | 4 | 16V | BAG, BLP |  | 85/115 | 08/03→ | BAE408AE | 15.0 | 30 | 52 |

**A3 Sportback (8PA)**

|         |   |     |          |  |        |        |          |      |    |    |
|---------|---|-----|----------|--|--------|--------|----------|------|----|----|
| 1.6     | 4 | 8V  | BGU      |  | 75/102 | 09/04→ | BAE907AE | 7.5  | 33 | 85 |
| 1.6 FSI | 4 | 16V | BLF, BLP |  | 85/115 | 09/04→ | BAE408AE | 15.0 | 30 | 52 |

**A4 (8D2, B5)**

|     |   |    |               |  |        |             |          |     |    |    |
|-----|---|----|---------------|--|--------|-------------|----------|-----|----|----|
| 1.6 | 4 | 8V | AHL, ANA, ARM |  | 74/101 | 01/95→07/00 | BAE907AE | 7.5 | 33 | 85 |
| 1.6 | 4 | 8V | ALZ           |  | 75/102 | 07/00→11/00 | BAE907AE | 7.5 | 33 | 85 |

**A4 (8E2, B6)**

|     |   |    |     |  |        |        |          |     |    |    |
|-----|---|----|-----|--|--------|--------|----------|-----|----|----|
| 1.6 | 4 | 8V | ALZ |  | 75/102 | 11/00→ | BAE907AE | 7.5 | 33 | 85 |
|-----|---|----|-----|--|--------|--------|----------|-----|----|----|

**A4 (8EC)**

|     |   |    |     |  |        |        |          |     |    |    |
|-----|---|----|-----|--|--------|--------|----------|-----|----|----|
| 1.6 | 4 | 8V | ALZ |  | 75/102 | 11/04→ | BAE907AE | 7.5 | 33 | 85 |
|-----|---|----|-----|--|--------|--------|----------|-----|----|----|

**A4 Avant (8D5, B5)**

|     |   |    |               |  |        |             |          |     |    |    |
|-----|---|----|---------------|--|--------|-------------|----------|-----|----|----|
| 1.6 | 4 | 8V | AHL, ANA, ARM |  | 74/101 | 03/96→07/00 | BAE907AE | 7.5 | 33 | 85 |
| 1.6 | 4 | 8V | ALZ           |  | 75/102 | 07/00→09/01 | BAE907AE | 7.5 | 33 | 85 |

**A4 Avant (8E5, B6)**

|     |   |    |     |  |        |        |          |     |    |    |
|-----|---|----|-----|--|--------|--------|----------|-----|----|----|
| 1.6 | 4 | 8V | ALZ |  | 75/102 | 09/01→ | BAE907AE | 7.5 | 33 | 85 |
|-----|---|----|-----|--|--------|--------|----------|-----|----|----|



|                 |   |     |   |          |             | Amp      | Out kV | Out mJ |    |
|---|---|-----|---|----------|-------------|----------|--------|--------|----|
| <b>... AUDI</b>  |   |     |   |          |             |          |        |        |    |
| <b>A4 Avant (8ED)</b>   |   |     |   |          |             |          |        |        |    |
| 1.6   | 4 | 8V  | ALZ   | 75/102   | 11/04→      | BAE907AE | 7.5    | 33     | 85 |
| <b>A6 (4A, C4)</b>  |   |     |   |          |             |          |        |        |    |
| 2.0   | 4 | 8V  | ABK   | ✓ 85/115 | 06/94→02/97 | BAE851AE | 6.5    | 28     | 85 |
| <b>CABRIOLET (8G7, B4)</b>  |   |     |   |          |             |          |        |        |    |
| 2.0 E   | 4 | 8V  | ABK   | ✓ 85/115 | 01/93→07/98 | BAE851AE | 6.5    | 28     | 85 |
| <b>COUPE (89, 8B)</b>   |   |     |   |          |             |          |        |        |    |
| 2.0   | 4 | 8V  | ABK   | ✓ 85/115 | 05/89→12/96 | BAE851AE | 6.5    | 28     | 85 |
| <b>CITROËN</b>   |   |     |   |          |             |          |        |        |    |
| <b>AX (ZA- )</b>  |   |     |   |          |             |          |        |        |    |
| 10  | 4 | 8V  | CDY (TU9M)  | ✓ 33/45  | 07/86→12/98 | BAE507BK | 7.5    | 26     | 90 |
| 10  | 4 | 8V  | CDZ (TU9M)  | 37/50    | 02/87→12/98 | BAE945A  | 7.5    | 27     | 53 |
| 11  | 4 | 8V  | H1B, HDZ (TU1M)                                     | ✓ 44/60  | 09/86→12/97 | BAE507BK | 7.5    | 26     | 90 |
| 14  | 4 | 8V  | K2A, K2B  | ✓ 62/84  | 01/88→12/92 | BAE507BK | 7.5    | 26     | 90 |
| 14  | 4 | 8V  | KDX (TU3M/Z), KDY (TU3FM), KDY (TU3M), KDZ (TU3M/Z) | ✓ 55/75  | 04/87→04/97 | BAE507BK | 7.5    | 26     | 90 |
| <b>BERLINGO (MF)</b>  |   |     |   |          |             |          |        |        |    |
| 1.1 i (MFHDZ)   | 4 | 8V  | HDZ (TU1M), HFX (TU1JP)                             | 44/60    | 07/96→      | BAE946A  | 7.5    | 27     | 53 |
| 1.4 i (MFKFX)   | 4 | 8V  | KFW (TU3JP), KFX (TU3JP)                            | 55/75    | 07/96→05/00 | BAE945A  | 7.5    | 27     | 53 |
| 1.4 i (MFKFX)   | 4 | 8V  | KFW (TU3JP), KFX (TU3JP)                            | 55/75    | 06/00→      | BAE946A  | 7.5    | 27     | 53 |
| 1.4 i bivalent  | 4 | 8V  |   | 55/75    | 04/03→      | BAE946A  | 7.5    | 27     | 53 |
| <b>C2</b>   |   |     |   |          |             |          |        |        |    |
| 1.1   | 4 | 8V  | HFX (TU1JP)   | 44/60    | 09/03→      | BAE946A  | 7.5    | 27     | 53 |
| 1.4   | 4 | 8V  | KFV (TU3JP)   | 54/73    | 09/03→      | BAE946A  | 7.5    | 27     | 53 |
| <b>C3</b>   |   |     |   |          |             |          |        |        |    |
| 1.1 i   | 4 | 8V  | HFX (TU1JP)   | 44/60    | 02/02→      | BAE946A  | 7.5    | 27     | 53 |
| 1.4 i BiFuel  | 4 | 8V  | KFV (TU3JP)   | 54/73    | 02/02→      | BAE946A  | 7.5    | 27     | 53 |
| <b>C3 Pluriel</b>   |   |     |   |          |             |          |        |        |    |
| 1.4   | 4 | 8V  | KFV (TU3JP)   | 54/73    | 05/03→      | BAE946A  | 7.5    | 27     | 53 |
| <b>SAXO (S0, S1)</b>  |   |     |   |          |             |          |        |        |    |
| 1.0 X   | 4 | 8V  | CDZ (TU9M)  | 33/45    | 05/96→11/98 | BAE945A  | 7.5    | 27     | 53 |
| 1.0 X   | 4 | 8V  | CDZ (TU9M)  | 37/50    | 05/98→06/00 | BAE945A  | 7.5    | 27     | 53 |
| 1.0 X   | 4 | 8V  | CDZ (TU9M)  | 37/50    | 07/00→      | BAE946A  | 7.5    | 27     | 53 |
| 1.1 X,SX  | 4 | 8V  | HDZ (TU1M)  | 40/54    | 05/96→06/00 | BAE945A  | 7.5    | 27     | 53 |
| 1.1 X,SX  | 4 | 8V  | HDZ (TU1M)  | 40/54    | 07/00→09/03 | BAE946A  | 7.5    | 27     | 53 |
| 1.1 X,SX  | 4 | 8V  | HDZ (TU1M), HFX (TU1JP)                             | 44/60    | 05/96→06/00 | BAE945A  | 7.5    | 27     | 53 |
| 1.1 X,SX  | 4 | 8V  | HDZ (TU1M), HFX (TU1JP)                             | 44/60    | 07/00→      | BAE946A  | 7.5    | 27     | 53 |
| 1.4 VTS   | 4 | 8V  | KFW (TU3JP), KFX (TU3JP)                            | 55/75    | 05/96→06/00 | BAE945A  | 7.5    | 27     | 53 |
| 1.4 VTS   | 4 | 8V  | KFW (TU3JP), KFX (TU3JP)                            | 55/75    | 07/00→06/03 | BAE946A  | 7.5    | 27     | 53 |
| 1.6 VTL,VTR   | 4 | 8V  | NFZ (TU5JP)   | 65/88    | 05/96→06/00 | BAE945A  | 7.5    | 27     | 53 |
| 1.6 VTL,VTR   | 4 | 8V  | NFZ (TU5JP)   | 65/88    | 07/00→06/03 | BAE946A  | 7.5    | 27     | 53 |
| 1.6 VTS   | 4 | 8V  | NFT   | 72/98    | 09/00→09/03 | BAE946A  | 7.5    | 27     | 53 |
| <b>XANTIA (X1)</b>  |   |     |   |          |             |          |        |        |    |
| 2.0 i 16V   | 4 | 16V | RFT (XU10J4, Z)                                     | 110/150  | 06/94→01/98 | BAE700AK | 6.2    | 27     | 30 |
| 2.0 i 16V   | 4 | 16V | RFV (XU10J4R)                                       | 97/132   | 06/95→01/98 | BAE700AK | 6.2    | 27     | 30 |
| 2.0 i 16V   | 4 | 16V | RFY (XU10J4/Z)                                      | 112/152  | 03/93→01/98 | BAE700AK | 6.2    | 27     | 30 |
| <b>XM (Y3)</b>  |   |     |   |          |             |          |        |        |    |
| 2.0   | 4 | 8V  |   | ✓ 84/114 | 05/89→04/94 | BAE507BK | 7.5    | 26     | 90 |
| 2.0 i   | 4 | 8V  | RDZ (XU10MZ)  | ✓ 79/107 | 05/89→04/94 | BAE507BK | 7.5    | 26     | 90 |
| 2.0 i   | 4 | 8V  | RFZ (XU10J2)  | ✓ 89/121 | 05/89→06/94 | BAE507BK | 7.5    | 26     | 90 |
| <b>XM Estate (Y3)</b>   |   |     |   |          |             |          |        |        |    |
| 2.0   | 4 | 8V  |   | ✓ 85/116 | 10/91→07/94 | BAE507BK | 7.5    | 26     | 90 |
| 2.0 i   | 4 | 8V  | RDZ (XU10MZ, XU102C)                                | ✓ 79/107 | 11/91→04/94 | BAE507BK | 7.5    | 26     | 90 |
| 2.0 i   | 4 | 8V  | RFZ (XU10J2)  | ✓ 89/121 | 11/91→04/94 | BAE507BK | 7.5    | 26     | 90 |
| <b>XSARA (N1)</b>   |   |     |   |          |             |          |        |        |    |
| 1.4 i   | 4 | 8V  | KFW (TU3JP), KFX (TU3JP)                            | 55/75    | 04/97→06/00 | BAE945A  | 7.5    | 27     | 53 |
| 1.4 i   | 4 | 8V  | KFW (TU3JP), KFX (TU3JP)                            | 55/75    | 07/00→      | BAE946A  | 7.5    | 27     | 53 |
| 1.6 i   | 4 | 8V  | NFZ (TU5JP)   | 65/88    | 04/97→09/00 | BAE945A  | 7.5    | 27     | 53 |
| 1.6 i 16V   | 4 | 16V | NFU (TU5JP4)  | 80/109   | 09/00→03/05 | BAE946A  | 7.5    | 27     | 53 |

CITROËN



kW / BHP



Amp

Out  
kVOut  
mJ
**... CITROËN**

**XSARA Break (N2)**

|          |   |     |                          |        |             |         |     |    |    |
|----------|---|-----|--------------------------|--------|-------------|---------|-----|----|----|
| 1.4 i    | 4 | 8V  | KFW (TU3JP), KFX (TU3JP) | 55/75  | 10/97→06/00 | BAE945A | 7.5 | 27 | 53 |
| 1.4 i    | 4 | 8V  | KFW (TU3JP), KFX (TU3JP) | 55/75  | 07/00→      | BAE946A | 7.5 | 27 | 53 |
| 1.6 i    | 4 | 8V  | NFZ (TU5JP)              | 65/88  | 10/97→09/00 | BAE945A | 7.5 | 27 | 53 |
| 1.6 i16V | 4 | 16V | NFU (TU5JP4)             | 80/109 | 09/00→08/05 | BAE946A | 7.5 | 27 | 53 |

**XSARA Coupe (N0)**

|       |   |    |                          |       |             |         |     |    |    |
|-------|---|----|--------------------------|-------|-------------|---------|-----|----|----|
| 1.4 i | 4 | 8V | KFW (TU3JP), KFX (TU3JP) | 55/75 | 03/98→06/00 | BAE945A | 7.5 | 27 | 53 |
| 1.4 i | 4 | 8V | KFW (TU3JP), KFX (TU3JP) | 55/75 | 07/00→03/05 | BAE946A | 7.5 | 27 | 53 |
| 1.6 i | 4 | 8V | NFZ (TU5JP)              | 65/88 | 02/98→09/00 | BAE945A | 7.5 | 27 | 53 |

**XSARA PICASSO (N68)**

|     |   |    |             |       |        |         |     |    |    |
|-----|---|----|-------------|-------|--------|---------|-----|----|----|
| 1.6 | 4 | 8V |             | 70/95 | 09/00→ | BAE946A | 7.5 | 27 | 53 |
| 1.6 | 4 | 8V | NFZ (TU5JP) | 65/88 | 06/00→ | BAE946A | 7.5 | 27 | 53 |

**ZX (N2)**

|          |   |     |   |   |         |             |          |     |    |    |
|----------|---|-----|---|---|---------|-------------|----------|-----|----|----|
| 1.1      | 4 | 8V  | HDZ (TU1M)                                | ✓ | 44/60   | 03/91→06/97 | BAE507BK | 7.5 | 26 | 90 |
| 1.4      | 4 | 8V  | KDZ (TU3M, Z)                             | ✓ | 55/75   | 03/91→06/97 | BAE507BK | 7.5 | 26 | 90 |
| 1.4 i    | 4 | 8V  | KDZ (TU3M/Z)/KFX (TU3JP)/<br>KDX (TU3M/Z) | ✓ | 55/75   | 03/91→06/97 | BAE507BK | 7.5 | 26 | 90 |
| 2.0 i16V | 4 | 16V | RFS (XU10J4RS)                            |   | 120/163 | 05/96→06/97 | BAE700AK | 6.2 | 27 | 30 |
| 2.0 i16V | 4 | 16V | RFT (XU10J4, Z)                           |   | 110/150 | 06/94→06/97 | BAE700AK | 6.2 | 27 | 30 |
| 2.0 i16V | 4 | 16V | RFT (XU10J4/Z), RFY (XU10J4/Z)            |   | 112/152 | 07/92→10/94 | BAE700AK | 6.2 | 27 | 30 |

**ZX Estate (N2)**

|       |   |    |                         |   |       |             |          |     |    |    |
|-------|---|----|-------------------------|---|-------|-------------|----------|-----|----|----|
| 1.4 i | 4 | 8V | KFX (TU3JP), KDY (TU3M) | ✓ | 55/75 | 10/93→10/97 | BAE507BK | 7.5 | 26 | 90 |
|-------|---|----|-------------------------|---|-------|-------------|----------|-----|----|----|

**CITROËN**

**BERLINGO Box (M )**

|                |   |    |                          |       |             |         |     |    |    |
|----------------|---|----|--------------------------|-------|-------------|---------|-----|----|----|
| 1.4 i (MBKFX)  | 4 | 8V | KFW (TU3JP), KFX (TU3JP) | 55/75 | 07/96→05/00 | BAE945A | 7.5 | 27 | 53 |
| 1.4 i (MBKFX)  | 4 | 8V | KFW (TU3JP), KFX (TU3JP) | 55/75 | 06/00→      | BAE946A | 7.5 | 27 | 53 |
| 1.4 i bivalent | 4 | 8V |                          | 55/75 | 04/03→      | BAE946A | 7.5 | 27 | 53 |

**FIAT**

**500**

|         |   |     |  |        |        |         |     |    |    |
|---------|---|-----|--|--------|--------|---------|-----|----|----|
| 1.2     | 4 | 8V  |  | 51/69  | 07/07→ | BAE940A | 7.5 | 28 | 45 |
| 1.4 16V | 4 | 16V |  | 74/101 | 07/07→ | BAE403C | 7.5 | 27 | 42 |

**BRAVA (182)**

|                  |   |     |            |        |             |          |     |    |    |
|------------------|---|-----|------------|--------|-------------|----------|-----|----|----|
| 1.6 16V (182.BB) | 4 | 16V | 182 A4.000 | 76/103 | 02/96→10/01 | BAE920AX | 7.5 | 22 | 50 |
| 1.6 16V (182.BH) | 4 | 16V | 182 A6.000 | 66/90  | 10/95→10/01 | BAE920AX | 7.5 | 22 | 50 |

**BRAVO**

|         |   |     |            |       |        |         |     |    |    |
|---------|---|-----|------------|-------|--------|---------|-----|----|----|
| 1.4 16V | 4 | 16V | 192 B2.000 | 66/90 | 04/07→ | BAE403C | 7.5 | 27 | 42 |
|---------|---|-----|------------|-------|--------|---------|-----|----|----|

**BRAVO (182)**

|                  |   |     |            |        |             |          |     |    |    |
|------------------|---|-----|------------|--------|-------------|----------|-----|----|----|
| 1.6 16V (182.AB) | 4 | 16V | 182 A4.000 | 76/103 | 03/96→10/01 | BAE920AX | 7.5 | 22 | 50 |
| 1.6 16V (182.AH) | 4 | 16V | 182 A6.000 | 66/90  | 10/95→10/01 | BAE920AX | 7.5 | 22 | 50 |

**CINQUECENTO (170)**

|                           |   |    |                          |       |             |         |     |    |    |
|---------------------------|---|----|--------------------------|-------|-------------|---------|-----|----|----|
| 0.7 (170AA)               | 2 | 4V | 170 A.000                | 23/31 | 12/91→01/96 | BAE800B | 6.3 | 25 | 40 |
| 0.7 i (170AD)             | 2 | 4V | 170 A.046                | 22/30 | 07/94→01/98 | BAE800B | 6.3 | 25 | 40 |
| 0.9 (170AB)               | 4 | 8V | 170 A1.000               | 30/41 | 07/91→12/93 | BAE800B | 6.3 | 25 | 40 |
| 0.9 i.e. (170AC)          | 4 | 8V | 170 A1.046               | 30/41 | 07/91→12/93 | BAE800B | 6.3 | 25 | 40 |
| 0.9 i.e. S (170AF, 170CF) | 4 | 8V | 1170 A1.000, 1170 A1.046 | 29/39 | 07/91→01/98 | BAE800B | 6.3 | 25 | 40 |
| 1.1 Sporting (170AH)      | 4 | 8V | 176 B2.000               | 40/54 | 10/94→01/98 | BAE800B | 6.3 | 25 | 40 |

**COUPE (FA/175)**

|               |   |     |            |         |             |         |     |    |    |
|---------------|---|-----|------------|---------|-------------|---------|-----|----|----|
| 2.0 16V Turbo | 4 | 16V | 175 A1.000 | 140/190 | 11/93→08/96 | BAE800B | 6.3 | 25 | 40 |
|---------------|---|-----|------------|---------|-------------|---------|-----|----|----|

**CROMA (154)**

|                            |   |    |                       |   |        |             |         |  |    |    |
|----------------------------|---|----|-----------------------|---|--------|-------------|---------|--|----|----|
| 1600                       | 4 | 8V | 154 A.048             | ✓ | 61/83  | 12/85→12/90 | BAE504F |  | 28 | 90 |
| 2000 CHT (154.AC)          | 4 | 8V | 154 A1.000            | ✓ | 66/90  | 12/85→02/89 | BAE504D |  | 28 | 90 |
| 2000 i.e. (154.AD)         | 4 |    | 154 C3.000, 834 B.000 | ✓ | 88/120 | 03/87→09/92 | BAE504D |  | 28 | 90 |
| 2000 i.e. (154.AD)         | 4 |    | 154 C3.000, 834 B.000 | ✓ | 88/120 | 03/87→09/92 | BAE504F |  | 28 | 90 |
| 2000 i.e. (154.AM, 154.LM) | 4 | 8V | 154 C3.046, 834 B.146 | ✓ | 85/116 | 10/87→08/96 | BAE504D |  | 28 | 90 |
| 2000 i.e. (154.AM)         | 4 | 8V | 834 B.048             | ✓ | 83/113 | 03/86→09/90 | BAE504F |  | 28 | 90 |



KW / BHP



Amp

Out  
kVOut  
mJ

## ... FIAT

**DOBLO (223)**

|                    |   |     |            |  |        |        |         |     |    |    |
|--------------------|---|-----|------------|--|--------|--------|---------|-----|----|----|
| 1.2                | 4 | 8V  | 223 A5.000 |  | 48/65  | 03/01→ | BAE800B | 6.3 | 25 | 40 |
| 1.4                | 4 | 8V  | 350 A1.000 |  | 57/77  | 10/05→ | BAE940A | 7.5 | 28 | 45 |
| 1.6                | 4 | 16V | 182 B6.000 |  | 68/92  | 09/02→ | BAE403B | 7.5 | 27 | 42 |
| 1.6 16V (223AXD1A) | 4 | 16V | 182 B6.000 |  | 76/103 | 10/01→ | BAE403B | 7.5 | 27 | 42 |
| 1.6 Natural Power  | 4 | 16V | 182 B6.000 |  | 76/103 | 09/02→ | BAE403B | 7.5 | 27 | 42 |

**DUNA (146 B)**

|        |   |    |            |   |       |             |         |     |    |    |
|--------|---|----|------------|---|-------|-------------|---------|-----|----|----|
| 60 1.1 | 4 | 8V | 146 A6.000 | ✓ | 43/58 | 01/87→12/91 | BAE506F | 7.5 | 28 | 90 |
| 70 1.3 | 4 | 8V | 146 A5.000 | ✓ | 49/67 | 01/87→12/91 | BAE506F | 7.5 | 28 | 90 |

**DUNA Weekend (146 B)**

|        |   |    |            |   |       |             |         |     |    |    |
|--------|---|----|------------|---|-------|-------------|---------|-----|----|----|
| 60 1.1 | 4 | 8V | 146 A6.000 | ✓ | 43/58 | 01/87→12/91 | BAE506F | 7.5 | 28 | 90 |
| 70 1.3 | 4 | 8V | 146 A5.000 | ✓ | 49/67 | 01/87→12/91 | BAE506F | 7.5 | 28 | 90 |

**GRANDE PUNTO (199)**

|         |   |     |            |  |       |        |         |     |    |    |
|---------|---|-----|------------|--|-------|--------|---------|-----|----|----|
| 1.2     | 4 | 8V  | 199 A4.000 |  | 48/65 | 10/05→ | BAE940A | 7.5 | 28 | 45 |
| 1.4     | 4 | 8V  | 350 A1.000 |  | 57/77 | 10/05→ | BAE940A | 7.5 | 28 | 45 |
| 1.4 16V | 4 | 16V | 199 A6.000 |  | 70/95 | 10/05→ | BAE403C | 7.5 | 27 | 42 |

**IDEA**

|         |   |     |            |  |       |        |         |     |    |    |
|---------|---|-----|------------|--|-------|--------|---------|-----|----|----|
| 1.4 16V | 4 | 16V | 843 A1.000 |  | 70/95 | 01/04→ | BAE403C | 7.5 | 27 | 42 |
| 1.4 16V | 4 | 16V | 843 A1.000 |  | 70/95 | 01/04→ | BAE940A | 7.5 | 28 | 45 |

**MAREA (185)**

|                     |   |     |                        |  |        |        |          |     |    |    |
|---------------------|---|-----|------------------------|--|--------|--------|----------|-----|----|----|
| 1.6 100 16V         | 4 | 16V | 182 A4.000             |  | 76/103 | 09/96→ | BAE920AX | 7.5 | 22 | 50 |
| 1.6 100 16V Bipower | 4 | 16V | 186 A4.000, 185 A3.000 |  | 76/103 | 04/99→ | BAE920AX | 7.5 | 22 | 50 |

**MAREA Weekend (185)**

|             |   |     |            |  |        |        |          |     |    |    |
|-------------|---|-----|------------|--|--------|--------|----------|-----|----|----|
| 1.6 100 16V | 4 | 16V | 182 A4.000 |  | 76/103 | 09/96→ | BAE920AX | 7.5 | 22 | 50 |
|-------------|---|-----|------------|--|--------|--------|----------|-----|----|----|

**MULTIPLA (186)**

|                             |   |     |            |  |        |        |          |     |    |    |
|-----------------------------|---|-----|------------|--|--------|--------|----------|-----|----|----|
| 1.6 100 16V (186AXA1A)      | 4 | 16V | 182 A4.000 |  | 76/103 | 04/99→ | BAE920AX | 7.5 | 22 | 50 |
| 1.6 16V Bipower (186AMB1A)  | 4 | 16V | 186 A4.000 |  | 76/103 | 04/99→ | BAE920AX | 7.5 | 22 | 50 |
| 1.6 16V Bipower (186AXC1A)  | 4 |     | 182 B6.000 |  | 76/103 | 10/01→ | BAE920AX | 7.5 | 22 | 50 |
| 1.6 16V Blupower (186AMATA) | 4 | 16V | 186 A3.000 |  | 70/95  | 04/99→ | BAE920AX | 7.5 | 22 | 50 |

**PALIO (178BX)**

|         |   |     |            |  |        |        |          |     |    |    |
|---------|---|-----|------------|--|--------|--------|----------|-----|----|----|
| 1.0     | 4 |     |            |  | 45/61  | 04/96→ | BAE800B  | 6.3 | 25 | 40 |
| 1.2     | 4 | 8V  | 178 E2.000 |  | 54/73  | 06/98→ | BAE800B  | 6.3 | 25 | 40 |
| 1.6 16V | 4 | 16V | 178 B3.000 |  | 74/100 | 04/96→ | BAE920AX | 7.5 | 22 | 50 |

**PALIO Weekend (178DX)**

|                      |   |     |            |  |        |             |          |     |    |    |
|----------------------|---|-----|------------|--|--------|-------------|----------|-----|----|----|
| 1.2 (178DX.G1A)      | 4 | 8V  | 178 B5.000 |  | 54/73  | 04/96→02/01 | BAE800B  | 6.3 | 25 | 40 |
| 1.2 (178DYA1A)       | 4 | 8V  | 188 A4.000 |  | 44/60  | 02/01→      | BAE800B  | 6.3 | 25 | 40 |
| 1.6 16V (178DX.D1A)  | 4 | 16V | 178 B3.000 |  | 74/101 | 04/96→02/01 | BAE920AX | 7.5 | 22 | 50 |
| 1.6 16V (178DYC1A06) | 4 | 16V | 182 B6.000 |  | 76/103 | 02/01→      | BAE403B  | 7.5 | 27 | 42 |

**PANDA (141A )**

|                   |   |    |                        |   |       |             |         |     |    |    |
|-------------------|---|----|------------------------|---|-------|-------------|---------|-----|----|----|
| 750 (141AM) CAT   | 4 | 8V | 156 A4.048             | ✓ | 25/34 | 01/95→12/97 | BAE506F | 7.5 | 28 | 90 |
| 900               | 4 | 8V | 1170 A1.046            |   | 29/39 | 04/92→12/96 | BAE800B | 6.3 | 25 | 40 |
| 1000 4x4          | 4 | 8V | 141 C2.000, 156 A2.246 | ✓ | 33/45 | 05/86→12/94 | BAE506D | 7.5 | 28 | 90 |
| 1000 4x4          | 4 | 8V | 156 A3.100, 156 A2.100 | ✓ | 32/44 | 01/86→07/89 | BAE506F | 7.5 | 28 | 90 |
| 1000 i.e. CAT     | 4 | 8V | 141 C2.000, 156 A2.246 |   | 33/45 | 10/87→08/98 | BAE800B | 6.3 | 25 | 40 |
| 1100              | 4 | 8V | 156 C.046              | ✓ | 37/50 | 05/91→12/99 | BAE506D | 7.5 | 28 | 90 |
| 1100              | 4 | 8V | 187 A1.000, 176 B2.000 |   | 40/54 | 02/95→09/03 | BAE800B | 6.3 | 25 | 40 |
| 1100 4x4          | 4 | 8V | 176 B2.000             |   | 40/54 | 02/95→07/04 | BAE800B | 6.3 | 25 | 40 |
| 1100 Trekking 4x4 | 4 | 8V | 156 C.046              |   | 37/50 | 10/91→07/04 | BAE800B | 6.3 | 25 | 40 |

**PANDA (169)**

|              |   |     |            |  |        |        |         |     |    |    |
|--------------|---|-----|------------|--|--------|--------|---------|-----|----|----|
| 1.1          | 4 | 8V  | 187 A1.000 |  | 40/54  | 09/03→ | BAE800B | 6.3 | 25 | 40 |
| 1.2          | 4 | 8V  | 188 A4.000 |  | 44/60  | 09/03→ | BAE800B | 6.3 | 25 | 40 |
| 1.2 4x4      | 4 | 8V  | 188 A4.000 |  | 44/60  | 10/04→ | BAE800B | 6.3 | 25 | 40 |
| 1.2 Bi-Power | 4 | 8V  | 188 A4.000 |  | 44/60  | 01/07→ | BAE800B | 6.3 | 25 | 40 |
| 1.4          | 4 | 16V | 169 A3.000 |  | 74/100 | 10/06→ | BAE403C | 7.5 | 27 | 42 |

**PUNTO (176)**

|            |   |     |                        |  |       |             |         |     |    |    |
|------------|---|-----|------------------------|--|-------|-------------|---------|-----|----|----|
| 55 1.1     | 4 | 8V  | 176 A6.000, 176 B2.000 |  | 40/54 | 09/93→09/99 | BAE800B | 6.3 | 25 | 40 |
| 60 1.2     | 4 | 8V  | 176 A7.000             |  | 43/58 | 01/94→09/99 | BAE800B | 6.3 | 25 | 40 |
| 60 1.2     | 4 | 8V  | 176 B1.000, 176 B4.000 |  | 44/60 | 03/94→09/99 | BAE800B | 6.3 | 25 | 40 |
| 75 1.2     | 4 | 8V  | 176 A8.000             |  | 54/73 | 01/94→09/99 | BAE800B | 6.3 | 25 | 40 |
| 85 16V 1.2 | 4 | 16V | 176 B9.000             |  | 63/86 | 04/97→09/99 | BAE800B | 6.3 | 25 | 40 |

FIAT



kW / BHP



Amp

Out  
kVOut  
mJ

## ... FIAT

**PUNTO (188)**

|  |   |    |            |  |       |        |         |     |    |    |
|--|---|----|------------|--|-------|--------|---------|-----|----|----|
| 1.2 60 (188.030, .050, .130, .150, .230, .250) | 4 | 8V | 188 A4.000 |  | 44/60 | 09/99→ | BAE800B | 6.3 | 25 | 40 |
| 1.2 Natural Power                              | 4 | 8V | 188 A4.000 |  | 44/60 | 09/03→ | BAE800B | 6.3 | 25 | 40 |
| 1.4  | 4 |    |            |  | 70/95 | 09/03→ | BAE403C | 7.5 | 27 | 42 |

**PUNTO Cabriolet (176C)**

|            |   |     |                        |  |       |             |         |     |    |    |
|------------|---|-----|------------------------|--|-------|-------------|---------|-----|----|----|
| 60 1.2     | 4 | 8V  | 176 A7.000             |  | 43/58 | 04/94→06/00 | BAE800B | 6.3 | 25 | 40 |
| 60 1.2     | 4 | 8V  | 176 B1.000, 176 B4.000 |  | 44/60 | 05/95→06/00 | BAE800B | 6.3 | 25 | 40 |
| 85 16V 1.2 | 4 | 16V | 176 B9.000             |  | 63/86 | 04/97→06/00 | BAE800B | 6.3 | 25 | 40 |

**REGATA (138)**

|             |   |    |                        |   |       |             |         |     |    |    |
|-------------|---|----|------------------------|---|-------|-------------|---------|-----|----|----|
| 70 1.3      | 4 | 8V | 149 A3.000, 149 A7.000 | ✓ | 48/65 | 09/83→07/89 | BAE506F | 7.5 | 28 | 90 |
| 75 1.5      | 4 | 8V | 138 C3.048, 138 B3.048 | ✓ | 55/75 | 12/83→12/87 | BAE506F | 7.5 | 28 | 90 |
| 75 i.e. 1.5 | 4 | 8V | 138 C2.048, 149 C1.000 | ✓ | 55/75 | 07/85→07/89 | BAE504D |     | 28 | 90 |
| 75 i.e. 1.5 | 4 | 8V | 138 C2.048, 149 C1.000 | ✓ | 55/75 | 07/85→07/89 | BAE506F | 7.5 | 28 | 90 |

**REGATA Weekend**

|                 |   |    |                       |   |       |             |         |     |    |    |
|-----------------|---|----|-----------------------|---|-------|-------------|---------|-----|----|----|
| 75 1.5          | 4 | 8V | 138 C3.048/138 B3.048 | ✓ | 55/75 | 09/84→07/89 | BAE506F | 7.5 | 28 | 90 |
| 75 1.5 i.e. CAT | 4 | 8V | 138 C2.048            | ✓ | 55/75 | 12/86→07/89 | BAE506F | 7.5 | 28 | 90 |

**RITMO (138A)**

|             |   |    |                        |   |       |             |         |     |    |    |
|-------------|---|----|------------------------|---|-------|-------------|---------|-----|----|----|
| 75 i.e. 1.5 | 4 | 8V | 149 C1.000, 138 C2.048 | ✓ | 55/75 | 10/85→05/87 | BAE506F | 7.5 | 28 | 90 |
|-------------|---|----|------------------------|---|-------|-------------|---------|-----|----|----|

**RITMO Mk II (138A)**

|            |   |    |                        |   |       |             |         |     |    |    |
|------------|---|----|------------------------|---|-------|-------------|---------|-----|----|----|
| 75 1.5 KAT | 4 | 8V | 149 C1.000, 138 C2.048 | ✓ | 55/75 | 09/85→12/88 | BAE506F | 7.5 | 28 | 90 |
|------------|---|----|------------------------|---|-------|-------------|---------|-----|----|----|

**SEICENTO (187)**

|                        |   |    |                        |  |       |        |         |     |    |    |
|------------------------|---|----|------------------------|--|-------|--------|---------|-----|----|----|
| 0.9 (187AXA, 187AXA1A) | 4 | 8V | 1170 A1.046            |  | 29/39 | 01/98→ | BAE800B | 6.3 | 25 | 40 |
| 1.1 (187AXB, 187AXB1A) | 4 | 8V | 187 A1.000, 176 B2.000 |  | 40/54 | 01/98→ | BAE800B | 6.3 | 25 | 40 |

**SIENA**

|         |   |     |            |  |        |        |          |     |    |    |
|---------|---|-----|------------|--|--------|--------|----------|-----|----|----|
| 1.2     | 4 | 8V  | 178 B5.000 |  | 54/73  | 09/98→ | BAE800B  | 6.3 | 25 | 40 |
| 1.4     | 4 | 8V  | 178 B2.000 |  | 51/69  | 04/96→ | BAE940A  | 7.5 | 28 | 45 |
| 1.6 16V | 4 | 16V |            |  | 78/106 | 09/98→ | BAE920AX | 7.5 | 22 | 50 |

**STILO (192)**

|                    |   |     |            |  |         |        |         |     |    |    |
|--------------------|---|-----|------------|--|---------|--------|---------|-----|----|----|
| 1.2 16V (192_XA1B) | 4 | 16V | 188 A5.000 |  | 59/80   | 02/02→ | BAE403C | 7.5 | 27 | 42 |
| 1.4 16V            | 4 | 16V | 843 A1.000 |  | 66/90   | 03/05→ | BAE403C | 7.5 | 27 | 42 |
| 1.4 16V            | 4 | 16V | 843 A1.000 |  | 70/95   | 01/04→ | BAE403C | 7.5 | 27 | 42 |
| 1.6 16V (192_XB1A) | 4 | 16V | 182 B6.000 |  | 76/103  | 10/01→ | BAE403B | 7.5 | 27 | 42 |
| 2.4 20V (192_XD1A) | 5 | 20V | 192 A2.000 |  | 125/170 | 10/01→ | BAE403D | 7.5 | 27 | 42 |

**STILO Multi Wagon (192)**

|         |   |     |            |  |        |        |         |     |    |    |
|---------|---|-----|------------|--|--------|--------|---------|-----|----|----|
| 1.4 16V | 4 | 16V | 843 A1.000 |  | 66/90  | 03/05→ | BAE403C | 7.5 | 27 | 42 |
| 1.4 16V | 4 | 16V | 843 A1.000 |  | 70/95  | 01/04→ | BAE403C | 7.5 | 27 | 42 |
| 1.6 16V | 4 | 16V | 182 B6.000 |  | 76/103 | 01/03→ | BAE403B | 7.5 | 27 | 42 |

**TEMPRA (159)**













|                           |   |    |                        |   |        |             |         |     |    |    |
|---------------------------|---|----|------------------------|---|--------|-------------|---------|-----|----|----|
| 1.4 i.e. (159.AC, 159.AX) | 4 | 8V | 836 A4.000, 160 A1.046 | ✓ | 51/69  | 03/92→08/96 | BAE504D |     | 28 | 90 |
| 1.4 i.e. (159.AC)         | 4 | 8V | 159 A2.000             | ✓ | 57/77  | 03/91→08/96 | BAE504D |     | 28 | 90 |
| 1.6                       | 4 | 8V | 159 A3.000             | ✓ | 63/86  | 03/90→04/93 | BAE504D |     | 28 | 90 |
| 1.6 i.e. (159.AE)         | 4 | 8V | 159 A3.046             | ✓ | 57/77  | 06/90→07/92 | BAE504D |     | 28 | 90 |
| 1.6 i.e. (159.AS, 159.AT) | 4 | 8V | 159 A3.048, 835 C1.000 | ✓ | 55/75  | 06/92→08/96 | BAE504D |     | 28 | 90 |
| 1.8 i.e. (159.AV)         | 4 | 8V | 835 C2.000             |   | 76/103 | 09/93→08/96 | BAE800B | 6.3 | 25 | 40 |
| 1.8 i.e. (159.AZ)         | 4 | 8V | 835 C4.000             |   | 66/90  | 09/93→08/96 | BAE800B | 6.3 | 25 | 40 |
| 1.8 i.e. (159.BY)         | 4 | 8V | 836 A5.000             |   | 74/101 | 10/94→08/96 | BAE800B | 6.3 | 25 | 40 |

**TEMPRA S.W. (159)**

|                           |   |    |                        |   |        |             |         |     |    |    |
|---------------------------|---|----|------------------------|---|--------|-------------|---------|-----|----|----|
| 1.4 i.e. (159.AC, 159.AX) | 4 | 8V | 836 A4.000, 160 A1.046 | ✓ | 51/69  | 10/92→08/96 | BAE504D |     | 28 | 90 |
| 1.6                       | 4 | 8V | 159 A3.000             | ✓ | 63/86  | 12/90→04/93 | BAE504D |     | 28 | 90 |
| 1.6 i.e. (159.AE)         | 4 | 8V | 159 A3.046, 835 C1.000 | ✓ | 57/78  | 10/90→08/96 | BAE504D |     | 28 | 90 |
| 1.6 i.e. (159.AS, 159.AT) | 4 | 8V | 159 A3.048, 835 C1.000 | ✓ | 55/75  | 10/92→08/96 | BAE504D |     | 28 | 90 |
| 1.8 i.e. (159.AV)         | 4 | 8V | 835 C2.000             |   | 76/103 | 09/93→08/96 | BAE800B | 6.3 | 25 | 40 |
| 1.8 i.e. (159.AZ)         | 4 | 8V | 835 C4.000             |   | 66/90  | 09/93→08/96 | BAE800B | 6.3 | 25 | 40 |
| 1.8 i.e. (159.BY)         | 4 | 8V | 836 A5.000             |   | 74/101 | 10/94→08/96 | BAE800B | 6.3 | 25 | 40 |

**TIPO (160)**

|                                   |   |    |                        |   |       |             |         |     |    |    |
|-----------------------------------|---|----|------------------------|---|-------|-------------|---------|-----|----|----|
| 1.1 (160.AA)                      | 4 | 8V | 160 A3.000             | ✓ | 41/56 | 01/88→10/91 | BAE506D | 7.5 | 28 | 90 |
| 1.4 (160.AC)                      | 4 | 8V | 160 A1.000, 160 A1.048 | ✓ | 52/71 | 07/87→12/89 | BAE504D |     | 28 | 90 |
| 1.4 (160.AC)                      | 4 | 8V | 160 A1.000, 160 A1.048 | ✓ | 52/71 | 07/87→12/89 | BAE506D | 7.5 | 28 | 90 |
| 1.4 i.e. (160.AP, 160.AD, 160.EA) | 4 | 8V | 160 A1.046, 836 A4.000 | ✓ | 51/69 | 05/89→04/95 | BAE504D |     | 28 | 90 |
| 1.6 (160.AE)                      | 4 | 8V | 160 A2.000             | ✓ | 61/83 | 01/88→10/91 | BAE504D |     | 28 | 90 |
| 1.6 i.e. (160.A1, 160.EC, 160.EB) | 4 | 8V | 159 A3.048, 835 C1.000 | ✓ | 55/75 | 10/92→04/95 | BAE504D |     | 28 | 90 |

|  |    |  |  |  |  |  | kw / BHP |  |  | Amp | Out kV | Out mJ |
|--|----|---|---|---|---|---|----------|---|---|-----|--------|--------|
| <b>... FIAT</b>       |    |   |   |   |   |   |          |   |   |     |        |        |
| <b>... TIPO (160)</b>  |    |   |   |   |   |   |          |   |   |     |        |        |
| 1.6 i.e. (160.AF)  | 4  | 8V  | 159 A3.046  | ✓   | 57/78   | 07/90→01/93   |          |   | BAE504D   |     | 28     | 90     |
| 1.8 i.e.   | 4  | 8V  | 835 C4.000  |   | 66/90   | 09/93→04/95   |          |   | BAE800B   | 6.3 | 25     | 40     |
| <b>UNO (146A/E)</b>  |    |   |   |   |   |   |          |   |   |     |        |        |
| 45 1.0 (146A.ED)   | 4  | 8V  | 156 A2.048/156 A2.100   | ✓   | 32/44   | 06/86→12/93   |          |   | BAE506D   | 7.5 | 28     | 90     |
| 45 1.0 (146A.ED)   | 4  | 8V  | 156 A2.048/156 A2.100   | ✓   | 32/44   | 06/86→12/93   |          |   | BAE506F   | 7.5 | 28     | 90     |
| 45 i.e. 1.0  | 4  | 8V  | 156 A2.246  | ✓   | 33/45   | 04/84→12/94   |          |   | BAE506D   | 7.5 | 28     | 90     |
| 50 i.e. 1.1  | 4  | 8V  | 146 C3.000  | ✓   | 36/49   | 06/92→12/93   |          |   | BAE506D   | 7.5 | 28     | 90     |
| 60 1.1   | 4  | 8V  | 160 A3.000  | ✓   | 42/57   | 04/89→12/92   |          |   | BAE506D   | 7.5 | 28     | 90     |
| 60 1.1 (146A.EG)   | 4  | 8V  | 146 A4.048  | ✓   | 43/58   | 05/85→08/89   |          |   | BAE506D   | 7.5 | 28     | 90     |
| 60 1.1 (146A.EG)   | 4  | 8V  | 146 A4.048  | ✓   | 43/58   | 05/85→08/89   |          |   | BAE506F   | 7.5 | 28     | 90     |
| 70   | 4  | 8V  | 149 A7.000  | ✓   | 48/65   | 05/85→08/89   |          |   | BAE506F   | 7.5 | 28     | 90     |
| 70 i.e. 1.4  | 4  | 8V  | 160 A1.046  | ✓   | 51/69   | 09/89→12/93   |          |   | BAE504D   |     | 28     | 90     |
| 70 S 1.4   | 4  | 8V  | 160 A1.048  | ✓   | 52/71   | 09/89→10/92   |          |   | BAE504D   |     | 28     | 90     |
| 75 i.e. 1.5  | 4  | 8V  | 138 C2.048, 149 C1.000  | ✓   | 55/75   | 10/85→12/93   |          |   | BAE504D   |     | 28     | 90     |
| <b>FIAT</b>           |    |   |   |   |   |   |          |   |   |     |        |        |
| <b>DOBLO Cargo (223)</b>   |    |   |   |   |   |   |          |   |   |     |        |        |
| 1.2  | 4  | 8V  | 223 A5.000  |   | 48/65   | 03/01→  |          |   | BAE800B   | 6.3 | 25     | 40     |
| 1.4  | 4  | 8V  | 350 A1.000  |   | 57/77   | 10/05→  |          |   | BAE940A   | 7.5 | 28     | 45     |
| 1.6 16V (223ZXD1A)   | 4  | 16V   | 182 B6.000  |   | 76/103  | 10/01→  |          |   | BAE403B   | 7.5 | 27     | 42     |
| 1.6 Natural Power  | 4  | 16V   | 182 B6.000  |   | 76/103  | 09/02→  |          |   | BAE403B   | 7.5 | 27     | 42     |
| <b>FIORINO Box (146 Uno)</b>   |    |   |   |   |   |   |          |   |   |     |        |        |
| 60 1.1   | 4  | 8V  | 146 A9.000  | ✓   | 40/54   | 05/88→12/93   |          |   | BAE506F   | 7.5 | 28     | 90     |
| 70 1.3   | 4  | 8V  | 146 A5.000  | ✓   | 49/67   | 01/88→12/94   |          |   | BAE506F   | 7.5 | 28     | 90     |
| 70 i.e. 1.4  | 4  | 8V  | 146 C5.000, 146 D5.000  | ✓   | 49/67   | 05/94→05/01   |          |   | BAE504D   |     | 28     | 90     |
| 75 i.e. 1.5  | 4  | 8V  | 149 C1.000  | ✓   | 55/75   | 05/88→12/93   |          |   | BAE504D   |     | 28     | 90     |
| 75 i.e. 1.6  | 4  | 8V  | 146 D6.000, 146 C6.000  | ✓   | 55/75   | 10/93→05/01   |          |   | BAE504D   |     | 28     | 90     |
| <b>FIORINO Pick Up (146 Uno)</b>   |    |   |   |   |   |   |          |   |   |     |        |        |
| 1.3  | 4  | 8V  | 146 A5.000  | ✓   | 49/67   | 01/88→12/94   |          |   | BAE506F   | 7.5 | 28     | 90     |
| 1.4  | 4  | 8V  | 146 D5.000  | ✓   | 49/67   | 05/94→05/01   |          |   | BAE504D   |     | 28     | 90     |
| 1.5 i.e.   | 4  | 8V  | 149 C1.000  | ✓   | 55/75   | 01/88→10/92   |          |   | BAE504D   |     | 28     | 90     |
| 1.6  | 4  | 8V  | 146 D6.000, 146 C6.000  | ✓   | 55/75   | 01/94→05/01   |          |   | BAE504D   |     | 28     | 90     |
| <b>PANDA Van (141 )</b>  |    |   |   |   |   |   |          |   |   |     |        |        |
| 1000 i.e   | 4  | 8V  | 156 A2.246  |   | 33/45   | 08/92→02/04   |          |   | BAE800B   | 6.3 | 25     | 40     |
| <b>PUNTO Van (176L)</b>  |    |   |   |   |   |   |          |   |   |     |        |        |
| 1.1  | 4  | 8V  | 176 B2.000  |   | 40/54   | 04/96→02/00   |          |   | BAE800B   | 6.3 | 25     | 40     |
| <b>PUNTO Van (188AX)</b>   |    |   |   |   |   |   |          |   |   |     |        |        |
| 1.2 60   | 4  | 8V  | 188 A4.000  |   | 44/60   | 02/00→  |          |   | BAE800B   | 6.3 | 25     | 40     |
| <b>STRADA (178E)</b>   |    |   |   |   |   |   |          |   |   |     |        |        |
| 1.2  | 4  | 8V  | 188 A4.000  |   | 44/60   | 04/03→  |          |   | BAE800B   | 6.3 | 25     | 40     |
| <b>FORD</b>         |    |   |   |   |   |   |          |   |   |     |        |        |
| <b>FOCUS C-MAX</b>   |    |   |   |   |   |   |          |   |   |     |        |        |
| 1.6  | 4  |   |   |   | 74/101  | 10/03→  |          |   | BAE960AE  | 7.0 | 27     | 48     |
| <b>GALAXY (WGR)</b>  |    |   |   |   |   |   |          |   |   |     |        |        |
| 2.0 i  | 4  | 8V  | ZVSA  |   | 85/115  | 11/95→  |          |   | BAE907AE  | 7.5 | 33     | 85     |
| <b>JAGUAR</b>       |    |   |   |   |   |   |          |   |   |     |        |        |
| <b>XJ</b>  |    |   |   |   |   |   |          |   |   |     |        |        |
| Sovereign V12  | 12 | 24V   | V 12 (90-93, 197KW)   | ✓   | 197/268   | 07/85→12/92   |          |   | BAE504DK  |     | 28     | 90     |
| <b>LAMBORGHINI</b>  |    |   |   |   |   |   |          |   |   |     |        |        |
| <b>DIABLO</b>  |    |   |   |   |   |   |          |   |   |     |        |        |
| VT   | 12 |   |   |   | 361/490   | 01/90→08/98   |          |   | BAE800B   | 6.3 | 25     | 40     |

LAMBORGHINI



kW / BHP



Amp

Out  
kVOut  
mJ**LANCIA****DEDRA (835)**

|                  |   |     |            |   |        |             |          |     |    |    |
|------------------|---|-----|------------|---|--------|-------------|----------|-----|----|----|
| 1.6 16V (835EI)  | 4 | 16V | 182 A4.000 |   | 76/103 | 01/96→07/99 | BAE920AX | 7.5 | 22 | 50 |
| 1.6 i.e. (835AB) | 4 | 8V  | 835 A1.046 | ✓ | 57/77  | 08/89→03/93 | BAE504D  |     | 28 | 90 |
| 1.8 i.e. (835FA) | 4 | 8V  | 836 A5.000 |   | 74/101 | 07/94→07/99 | BAE800B  | 6.3 | 25 | 40 |

**DEDRA SW (835)**

|                  |   |    |            |  |        |             |         |     |    |    |
|------------------|---|----|------------|--|--------|-------------|---------|-----|----|----|
| 1.8 i.e. (835FA) | 4 | 8V | 836 A5.000 |  | 74/101 | 07/94→07/99 | BAE800B | 6.3 | 25 | 40 |
|------------------|---|----|------------|--|--------|-------------|---------|-----|----|----|

**DELTA (831AB0)**

|                                      |   |     |                        |   |         |             |         |     |    |    |
|--------------------------------------|---|-----|------------------------|---|---------|-------------|---------|-----|----|----|
| 1.3 (831AB.011)                      | 4 | 8V  | 831 A2.000, 831 B.000  | ✓ | 55/75   | 09/79→08/92 | BAE506F | 7.5 | 28 | 90 |
| 1.5 (831AB.025)                      | 4 | 8V  | 831 A1.000, 831 B1.000 | ✓ | 63/86   | 09/79→12/92 | BAE504F |     | 28 | 90 |
| 2.0 16V HF Evo Integrale (831AB.027) | 4 | 16V | 831 E5.000, 831 E5.046 |   | 155/211 | 06/93→01/94 | BAE800B | 6.3 | 25 | 40 |

**DELTA Mk II (836)**

|                         |   |     |                        |   |         |             |          |     |    |    |
|-------------------------|---|-----|------------------------|---|---------|-------------|----------|-----|----|----|
| 1.4 i.e. (836AF, 836AH) | 4 | 8V  | 160 A1.046, 836 A4.000 | ✓ | 51/69   | 10/94→08/99 | BAE504D  |     | 28 | 90 |
| 1.6 i.e. (836AP)        | 4 | 8V  | 182 A6.000             |   | 66/90   | 03/96→08/99 | BAE920AX | 7.5 | 22 | 50 |
| 1.6 i.e. 16V (836A0)    | 4 | 16V | 182 A4.000             |   | 76/103  | 01/96→08/99 | BAE920AX | 7.5 | 22 | 50 |
| 1.8 i.e. (836AE)        | 4 | 8V  | 835 C2.000             |   | 76/103  | 06/93→08/99 | BAE800B  | 6.3 | 25 | 40 |
| 2.0 16V Turbo (836AB)   | 4 | 16V | 836 A2.000             |   | 137/186 | 06/93→08/99 | BAE800B  | 6.3 | 25 | 40 |
| 2.0 16V Turbo (836AS)   | 4 | 16V | 175 A4.000             |   | 142/193 | 07/96→08/99 | BAE800B  | 6.3 | 25 | 40 |

**LYBRA (839AX)**

|                    |   |     |                        |  |        |        |          |     |    |    |
|--------------------|---|-----|------------------------|--|--------|--------|----------|-----|----|----|
| 1.6 16V (839AXA1A) | 4 | 16V | 182 A4.000, 182 B6.000 |  | 76/103 | 07/99→ | BAE920AX | 7.5 | 22 | 50 |
|--------------------|---|-----|------------------------|--|--------|--------|----------|-----|----|----|

**LYBRA SW (839BX)**

|                    |   |     |            |  |        |        |          |     |    |    |
|--------------------|---|-----|------------|--|--------|--------|----------|-----|----|----|
| 1.6 16V (839BXA1A) | 4 | 16V | 182 A4.000 |  | 76/103 | 07/99→ | BAE920AX | 7.5 | 22 | 50 |
|--------------------|---|-----|------------|--|--------|--------|----------|-----|----|----|

**MUSA**

|     |   |     |             |  |       |        |         |     |    |    |
|-----|---|-----|-------------|--|-------|--------|---------|-----|----|----|
| 1.4 | 4 | 8V  |             |  | 57/77 | 09/05→ | BAE940A | 7.5 | 28 | 45 |
| 1.4 | 4 | 16V | 843 A 1.000 |  | 70/95 | 10/04→ | BAE403C | 7.5 | 27 | 42 |

**PRISMA (831AB0)**

|     |   |    |            |   |       |             |         |  |    |    |
|-----|---|----|------------|---|-------|-------------|---------|--|----|----|
| 1.5 | 4 | 8V | 831 B1.000 | ✓ | 59/80 | 08/86→02/92 | BAE504F |  | 28 | 90 |
|-----|---|----|------------|---|-------|-------------|---------|--|----|----|

**THEMA (834)**

|                         |   |     |            |   |         |             |         |     |    |    |
|-------------------------|---|-----|------------|---|---------|-------------|---------|-----|----|----|
| 2000 16V Turbo (834AC)  | 4 | 16V | 834 C1.000 |   | 133/181 | 12/88→06/90 | BAE800B | 6.3 | 25 | 40 |
| 2000 i.e. (834AB)       | 4 | 8V  | 834 B1.000 | ✓ | 86/117  | 09/88→05/92 | BAE504D |     | 28 | 90 |
| 2000 i.e.               | 4 | 8V  | 834 B.048  | ✓ | 83/113  | 03/86→09/88 | BAE504D |     | 28 | 90 |
| 2000 i.e. (834BV)       | 4 | 8V  | 834 B.146  | ✓ | 85/115  | 09/87→05/92 | BAE504D |     | 28 | 90 |
| 2000 i.e. 16V (834AI)   | 4 | 16V | 834 B2.246 |   | 104/141 | 02/89→05/92 | BAE800B | 6.3 | 25 | 40 |
| 2000 i.e. Turbo (834CV) | 4 | 8V  | 834 C.146  | ✓ | 110/150 | 07/86→05/90 | BAE504D |     | 28 | 90 |

**THEMA SW (834)**

|                             |   |     |            |   |         |             |         |     |    |    |
|-----------------------------|---|-----|------------|---|---------|-------------|---------|-----|----|----|
| 2000 i.e. 16V Turbo (834AC) | 4 | 16V | 834 C1.000 |   | 133/181 | 12/88→06/90 | BAE800B | 6.3 | 25 | 40 |
| 2000 Turbo 16V              | 4 | 8V  | 834 C.146  | ✓ | 110/149 | 01/89→03/92 | BAE506F | 7.5 | 28 | 90 |

**Y (840A)**

|                      |   |     |                        |  |       |             |         |     |    |    |
|----------------------|---|-----|------------------------|--|-------|-------------|---------|-----|----|----|
| 1.1 (840AE)          | 4 | 8V  | 176 B2.000             |  | 40/54 | 11/95→09/03 | BAE800B | 6.3 | 25 | 40 |
| 1.2 (840AA, 840AF1A) | 4 | 8V  | 188 A4.000, 840 A3.000 |  | 44/60 | 03/96→09/03 | BAE800B | 6.3 | 25 | 40 |
| 1.2 16V (840AD)      | 4 | 16V | 176 B9.000             |  | 63/86 | 04/97→09/03 | BAE800B | 6.3 | 25 | 40 |

**Y10 (156)**

|                        |   |    |                        |   |       |             |         |     |    |    |
|------------------------|---|----|------------------------|---|-------|-------------|---------|-----|----|----|
| 1.0 Fire (156AE) CAT   | 4 | 8V | 156 A2.246             | ✓ | 33/45 | 10/87→02/92 | BAE506D | 7.5 | 28 | 90 |
| 1.0 Fire (156B, 156AD) | 4 | 8V | 156 A 2.100            | ✓ | 32/44 | 06/85→06/91 | BAE506D | 7.5 | 28 | 90 |
| 1.1 i.e. Fire (156AG)  | 4 | 8V | 156 C.046              | ✓ | 37/50 | 07/89→09/95 | BAE506D | 7.5 | 28 | 90 |
| 1.3 i.e. Fire (156AB)  | 4 | 8V | 156 B.000              | ✓ | 56/76 | 11/87→05/93 | BAE504D |     | 28 | 90 |
| 1.3 i.e. Fire (156AF)  | 4 | 8V | 156 B.000, 146 A 5.046 | ✓ | 53/72 | 02/89→12/95 | BAE504D |     | 28 | 90 |

**YPSILON**











|     |   |     |             |  |       |        |         |     |    |    |
|-----|---|-----|-------------|--|-------|--------|---------|-----|----|----|
| 1.2 | 4 | 8V  | 188 A4.000  |  | 44/60 | 10/03→ | BAE800B | 6.3 | 25 | 40 |
| 1.2 | 4 | 16V | 188 A5.000  |  | 59/80 | 10/03→ | BAE403C | 7.5 | 27 | 42 |
| 1.4 | 4 | 16V | 843 A 1.000 |  | 70/95 | 10/03→ | BAE403C | 7.5 | 27 | 42 |

**LAND ROVER****FREELANDER (LN)**

|        |   |     |        |  |         |        |         |     |    |    |
|--------|---|-----|--------|--|---------|--------|---------|-----|----|----|
| 2.5 V6 | 6 | 24V | 25 K4F |  | 130/177 | 11/00→ | BAE403H | 7.5 | 27 | 42 |
|--------|---|-----|--------|--|---------|--------|---------|-----|----|----|

**MASERATI****BITURBO**

|       |   |     |     |   |         |             |         |  |    |    |
|-------|---|-----|-----|---|---------|-------------|---------|--|----|----|
| 4.24V | 6 | 24V | 475 | ✓ | 180/245 | 04/90→12/94 | BAE504F |  | 28 | 90 |
|-------|---|-----|-----|---|---------|-------------|---------|--|----|----|

|   |   |  |  |  |  |  | KW / BHP |  |  | Amp | Out kV | Out mJ |
|---|---|---|---|---|---|---|----------|---|---|-----|--------|--------|
| <b>... MASERATI</b>  |   |   |   |   |   |   |          |   |   |     |        |        |
| <b>BITURBO (70, 77)</b>   |   |   |   |   |   |   |          |   |   |     |        |        |
| 2.24V   | 6 | 24V   | 475   | ✓   | 180/245   | 03/89→12/94   |          | BAE504F   |   | 28  | 90     |        |
| <b>GIBLI II</b>   |   |   |   |   |   |   |          |   |   |     |        |        |
| 2.0 24V Biturbo   | 6 | 24V   |   |   | 225/306   | 05/92→  |          | BAE700AK  | 6.2   | 27  | 30     |        |
| <b>QUATTROPORTE II</b>  |   |   |   |   |   |   |          |   |   |     |        |        |
| 2.0 Biturbo   | 6 | 24V   | 24V DOHC  |   | 211/287   | 03/94→  |          | BAE700AK  | 6.2   | 27  | 30     |        |
| 2.8 Biturbo   | 6 |   |   |   | 209/284   | 03/94→  |          | BAE700AK  | 6.2   | 27  | 30     |        |
| <b>MG</b>            |   |   |   |   |   |   |          |   |   |     |        |        |
| <b>MG ZS</b>  |   |   |   |   |   |   |          |   |   |     |        |        |
| 180   | 6 | 24V   | 25 K4F  |   | 130/177   | 07/01→  |          | BAE403H   | 7.5   | 27  | 42     |        |
| <b>MG ZS Hatchback</b>  |   |   |   |   |   |   |          |   |   |     |        |        |
| 180   | 6 | 24V   | 25 K4F  |   | 130/177   | 07/01→  |          | BAE403H   | 7.5   | 27  | 42     |        |
| <b>MG ZT</b>  |   |   |   |   |   |   |          |   |   |     |        |        |
| 160   | 6 | 24V   | 25 K4F  |   | 118/160   | 06/01→  |          | BAE403H   | 7.5   | 27  | 42     |        |
| 180   | 6 | 24V   | 25 K4F  |   | 130/177   | 01/03→  |          | BAE403H   | 7.5   | 27  | 42     |        |
| 190   | 6 | 24V   | 25 K4F  |   | 140/190   | 06/01→  |          | BAE403H   | 7.5   | 27  | 42     |        |
| <b>MG ZT-T</b>  |   |   |   |   |   |   |          |   |   |     |        |        |
| 160   | 6 | 24V   | 25 K4F  |   | 118/160   | 10/01→  |          | BAE403H   | 7.5   | 27  | 42     |        |
| 180   | 6 | 24V   | 25 K4F  |   | 130/177   | 01/03→  |          | BAE403H   | 7.5   | 27  | 42     |        |
| 190   | 6 | 24V   | 25 K4F  |   | 140/190   | 10/01→  |          | BAE403H   | 7.5   | 27  | 42     |        |
| <b>NISSAN</b>      |   |   |   |   |   |   |          |   |   |     |        |        |
| <b>PRIMASTAR Box</b>  |   |   |   |   |   |   |          |   |   |     |        |        |
| 2.0   | 4 |   |   |   | 88/120  | 02/03→  |          | BAE409A   | 7.5   | 26  | 37     |        |
| <b>PRIMASTAR Bus</b>  |   |   |   |   |   |   |          |   |   |     |        |        |
| 2.0   | 4 |   | F4R 720, F4R 722  |   | 88/120  | 03/01→  |          | BAE409A   | 7.5   | 26  | 37     |        |
| <b>OPEL</b>        |   |   |   |   |   |   |          |   |   |     |        |        |
| <b>ASTRA G Convertible</b>  |   |   |   |   |   |   |          |   |   |     |        |        |
| 1.6 16V   | 4 | 16V   | Z 16 XE   |   | 74/101  | 03/01→10/05   |          | BAE965A   | 7.5   | 23  | 28     |        |
| <b>ASTRA G Hatchback (F48 , F08 )</b>   |   |   |   |   |   |   |          |   |   |     |        |        |
| 1.4 16V   | 4 | 16V   | X 14 XE, Z 14 XE  |   | 66/90   | 02/98→01/05   |          | BAE965A   | 7.5   | 23  | 28     |        |
| 1.6 16V   | 4 | 16V   | X 16 XEL, Z 16 XE   |   | 74/101  | 02/98→01/05   |          | BAE965A   | 7.5   | 23  | 28     |        |
| <b>ASTRA G Saloon (F69 )</b>  |   |   |   |   |   |   |          |   |   |     |        |        |
| 1.4 16V   | 4 | 16V   | X 14 XE, Z 14 XE  |   | 66/90   | 09/98→01/05   |          | BAE965A   | 7.5   | 23  | 28     |        |
| 1.6 16V   | 4 | 16V   | X 16 XEL, Z 16 XE   |   | 74/101  | 09/98→01/05   |          | BAE965A   | 7.5   | 23  | 28     |        |
| <b>ASTRA G Station wagon (F35 )</b>   |   |   |   |   |   |   |          |   |   |     |        |        |
| 1.4 16V   | 4 | 16V   | X 14 XE, Z 14 XE  |   | 66/90   | 06/98→07/04   |          | BAE965A   | 7.5   | 23  | 28     |        |
| 1.6 16V   | 4 | 16V   | X 16 XEL, Z 16 XE   |   | 74/101  | 02/98→07/04   |          | BAE965A   | 7.5   | 23  | 28     |        |
| <b>CORSA C (F08, F68)</b>   |   |   |   |   |   |   |          |   |   |     |        |        |
| 1.4   | 4 | 16V   | Z 14 XE   |   | 66/90   | 09/00→  |          | BAE965A   | 7.5   | 23  | 28     |        |
| <b>MERIVA</b>   |   |   |   |   |   |   |          |   |   |     |        |        |
| 1.6 16V   | 4 | 16V   | Z 16 XE   |   | 74/101  | 05/03→  |          | BAE965A   | 7.5   | 23  | 28     |        |
| <b>VECTRA B (36 )</b>   |   |   |   |   |   |   |          |   |   |     |        |        |
| 1.6 i 16V   | 4 | 16V   | X 16 XEL, Y 16 XE, Z 16 XE  |   | 74/101  | 10/95→04/02   |          | BAE965A   | 7.5   | 23  | 28     |        |
| <b>VECTRA B Hatchback (38 )</b>   |   |   |   |   |   |   |          |   |   |     |        |        |
| 1.6 i 16V   | 4 | 16V   | X 16 XEL, Y 16 XE, Z 16 XE  |   | 74/101  | 10/95→07/02   |          | BAE965A   | 7.5   | 23  | 28     |        |
| <b>VECTRA B Station wagon (31 )</b>   |   |   |   |   |   |   |          |   |   |     |        |        |
| 1.6 i 16V   | 4 | 16V   | X 16 XEL, Y 16 XE, Z 16 XE  |   | 74/101  | 11/96→07/02   |          | BAE965A   | 7.5   | 23  | 28     |        |
| <b>VECTRA C</b>   |   |   |   |   |   |   |          |   |   |     |        |        |
| 1.6 16V   | 4 | 16V   | Z 16 XE   |   | 74/101  | 06/04→  |          | BAE965A   | 7.5   | 23  | 28     |        |
| <b>VECTRA C Estate</b>  |   |   |   |   |   |   |          |   |   |     |        |        |
| 1.6 16V   | 4 | 16V   | Z 16 XE   |   | 74/100  | 06/04→  |          | BAE965A   | 7.5   | 23  | 28     |        |
| <b>VECTRA C GTS</b>   |   |   |   |   |   |   |          |   |   |     |        |        |
| 1.6 16V   | 4 | 16V   | Z 16 XE   |   | 74/100  | 08/05→  |          | BAE965A   | 7.5   | 23  | 28     |        |

OPEL



kW / BHP



Amp

Out  
kVOut  
mJ
**... OPEL**

**ZAFIRA (F75 )**

|         |   |     |                   |        |             |         |     |    |    |
|---------|---|-----|-------------------|--------|-------------|---------|-----|----|----|
| 1.6 16V | 4 | 16V | X 16 XEL, Z 16 XE | 74/101 | 04/99→06/05 | BAE965A | 7.5 | 23 | 28 |
| 1.6 CNG | 4 | 16V | Z 16 YNG          | 71/96  | 09/01→06/05 | BAE965A | 7.5 | 23 | 28 |

**OPEL**

**VIVARO Box**

|         |   |     |                      |        |        |         |     |    |    |
|---------|---|-----|----------------------|--------|--------|---------|-----|----|----|
| 2.0 16V | 4 | 16V | F4R 720 >ENG.C002324 | 88/120 | 08/01→ | BAE409A | 7.5 | 26 | 37 |
|---------|---|-----|----------------------|--------|--------|---------|-----|----|----|

**VIVARO Box (F7)**

|            |   |  |              |        |        |         |     |    |    |
|------------|---|--|--------------|--------|--------|---------|-----|----|----|
| 2.0 ECOTEC | 4 |  | >ENG.C002324 | 86/117 | 08/06→ | BAE409A | 7.5 | 26 | 37 |
|------------|---|--|--------------|--------|--------|---------|-----|----|----|

**VIVARO Combi**

|         |   |     |                      |        |        |         |     |    |    |
|---------|---|-----|----------------------|--------|--------|---------|-----|----|----|
| 2.0 16V | 4 | 16V | F4R 720 >ENG.C002324 | 88/120 | 08/01→ | BAE409A | 7.5 | 26 | 37 |
|---------|---|-----|----------------------|--------|--------|---------|-----|----|----|

**VIVARO Combi (J7)**

|            |   |  |              |        |        |         |     |    |    |
|------------|---|--|--------------|--------|--------|---------|-----|----|----|
| 2.0 ECOTEC | 4 |  | >ENG.C002324 | 86/117 | 08/06→ | BAE409A | 7.5 | 26 | 37 |
|------------|---|--|--------------|--------|--------|---------|-----|----|----|

**PEUGEOT**

**106 (1A, 1C)**

|     |   |    |                         |   |       |             |          |     |    |    |
|-----|---|----|-------------------------|---|-------|-------------|----------|-----|----|----|
| 1.1 | 4 | 8V | HDZ (TU1M)              | ✓ | 44/60 | 09/91→04/96 | BAE507BK | 7.5 | 26 | 90 |
| 1.4 | 4 | 8V | KDX (TU3MC), KDY (TU3M) | ✓ | 55/75 | 09/91→04/96 | BAE507BK | 7.5 | 26 | 90 |
| 1.4 | 4 | 8V | KFZ (TU3J2/Z)           | ✓ | 69/94 | 09/91→04/96 | BAE507BK | 7.5 | 26 | 90 |

**106 Mk II (1)**

|       |   |    |                          |  |        |             |         |     |    |    |
|-------|---|----|--------------------------|--|--------|-------------|---------|-----|----|----|
| 1.0 i | 4 | 8V | CDZ (TU9M)               |  | 37/50  | 01/97→      | BAE945A | 7.5 | 27 | 53 |
| 1.1 i | 4 | 8V | HDY (TU1M)               |  | 40/54  | 01/97→06/00 | BAE945A | 7.5 | 27 | 53 |
| 1.1 i | 4 | 8V | HDY (TU1M)               |  | 40/54  | 07/00→      | BAE946A | 7.5 | 27 | 53 |
| 1.1 i | 4 | 8V | HDZ (TU1M), HFX (TU1JP)  |  | 44/60  | 05/96→06/00 | BAE945A | 7.5 | 27 | 53 |
| 1.1 i | 4 | 8V | HDZ (TU1M), HFX (TU1JP)  |  | 44/60  | 06/00→      | BAE946A | 7.5 | 27 | 53 |
| 1.4 i | 4 | 8V | KFW (TU3JP), KFX (TU3JP) |  | 55/75  | 05/96→06/00 | BAE945A | 7.5 | 27 | 53 |
| 1.4 i | 4 | 8V | KFW (TU3JP), KFX (TU3JP) |  | 55/75  | 06/00→      | BAE946A | 7.5 | 27 | 53 |
| 1.6 i | 4 | 8V | NFW (TU5J2), NFX (TU5J2) |  | 74/101 | 05/96→06/00 | BAE945A | 7.5 | 27 | 53 |
| 1.6 i | 4 | 8V | NFW (TU5J2), NFX (TU5J2) |  | 74/101 | 06/00→      | BAE946A | 7.5 | 27 | 53 |
| 1.6 i | 4 | 8V | NFZ (TU5JP)              |  | 65/88  | 05/96→06/00 | BAE945A | 7.5 | 27 | 53 |
| 1.6 i | 4 | 8V | NFZ (TU5JP)              |  | 65/88  | 06/00→      | BAE946A | 7.5 | 27 | 53 |

**205 (741A/C)**

|     |   |    |            |   |       |             |          |     |    |    |
|-----|---|----|------------|---|-------|-------------|----------|-----|----|----|
| 1.0 | 4 | 8V | 108C (XV8) | ✓ | 33/45 | 02/83→10/87 | BAE507AK | 7.5 | 26 | 90 |
| 1.1 | 4 | 8V | 109F (XW7) | ✓ | 37/50 | 02/83→10/87 | BAE507AK | 7.5 | 26 | 90 |
| 1.1 | 4 | 8V | 109N (XW7) | ✓ | 36/49 | 02/83→10/87 | BAE507AK | 7.5 | 26 | 90 |

**206 (2A/C)**

|       |   |    |                          |  |       |             |         |     |    |    |
|-------|---|----|--------------------------|--|-------|-------------|---------|-----|----|----|
| 1.1 i | 4 | 8V | HFX (TU1JP), HFZ (TU1JP) |  | 44/60 | 09/98→06/00 | BAE945A | 7.5 | 27 | 53 |
| 1.1 i | 4 | 8V | HFX (TU1JP), HFZ (TU1JP) |  | 44/60 | 07/00→      | BAE946A | 7.5 | 27 | 53 |
| 1.4 i | 4 | 8V | KFW (TU3JP), KFX (TU3JP) |  | 55/75 | 09/98→06/00 | BAE945A | 7.5 | 27 | 53 |
| 1.4 i | 4 | 8V | KFW (TU3JP), KFX (TU3JP) |  | 55/75 | 07/00→      | BAE946A | 7.5 | 27 | 53 |
| 1.6 i | 4 | 8V | NFZ (TU5JP)              |  | 65/88 | 09/98→12/00 | BAE945A | 7.5 | 27 | 53 |

**206 SW (2E/K)**

|         |   |     |             |  |       |        |         |     |    |    |
|---------|---|-----|-------------|--|-------|--------|---------|-----|----|----|
| 1.1     | 4 | 8V  | HFX (TU1JP) |  | 44/60 | 07/02→ | BAE946A | 7.5 | 27 | 53 |
| 1.4     | 4 | 8V  | KFW (TU3JP) |  | 55/75 | 07/02→ | BAE946A | 7.5 | 27 | 53 |
| 1.4 16V | 4 | 16V |             |  | 65/88 | 10/03→ | BAE946A | 7.5 | 27 | 53 |

**306 (7B, N3, N5)**

|         |   |     |  |  |         |             |          |     |    |    |
|---------|---|-----|--|--|---------|-------------|----------|-----|----|----|
| 1.4 SL  | 4 | 8V  | KDX (TU3MC), KFW (TU3JP),<br>KFX (TU3JP) |  | 55/75   | 06/94→06/00 | BAE945A  | 7.5 | 27 | 53 |
| 1.4 SL  | 4 | 8V  | KDX (TU3MC), KFW (TU3JP),<br>KFX (TU3JP) |  | 55/75   | 07/00→01/05 | BAE946A  | 7.5 | 27 | 53 |
| 1.6     | 4 | 8V  | NFT                                      |  | 72/98   | 10/00→05/01 | BAE946A  | 7.5 | 27 | 53 |
| 1.6 SR  | 4 | 8V  | NFZ (TU5JP)                              |  | 65/88   | 06/94→10/00 | BAE945A  | 7.5 | 27 | 53 |
| 2.0 S16 | 4 | 16V | RFT (XU10J4)                             |  | 110/149 | 06/94→      | BAE700AK | 6.2 | 27 | 30 |

**306 Break (7E, N3, N5)**

|     |   |    |                          |  |       |             |         |     |    |    |
|-----|---|----|--------------------------|--|-------|-------------|---------|-----|----|----|
| 1.4 | 4 | 8V | KFW (TU3JP), KFX (TU3JP) |  | 55/75 | 03/97→06/00 | BAE945A | 7.5 | 27 | 53 |
| 1.4 | 4 | 8V | KFW (TU3JP), KFX (TU3JP) |  | 55/75 | 07/00→04/02 | BAE946A | 7.5 | 27 | 53 |
| 1.6 | 4 | 8V | NFT                      |  | 72/98 | 10/00→04/02 | BAE946A | 7.5 | 27 | 53 |
| 1.6 | 4 | 8V | NFZ (TU5JP)              |  | 65/88 | 03/97→10/00 | BAE945A | 7.5 | 27 | 53 |



|                     |   |  |                                       |  |  |  |             |  |  | kW / BHP |     |  |    |  |  | Amp |  | Out kV |  | Out mJ |  |
|--|---|---|---------------------------------------|---|--|---|-------------|---|--|----------|-----|---|----|---|--|-----|--|--------|--|--------|--|
| <b>... PEUGEOT</b>  |   |   |                                       |   |  |   |             |   |  |          |     |   |    |   |  |     |  |        |  |        |  |
| <b>306 Convertible (7D, N3, N5)</b>  |   |   |                                       |   |  |   |             |   |  |          |     |   |    |   |  |     |  |        |  |        |  |
| 1.6  | 4 | 8V  | NFT                                   |   |  | 72/98   | 10/00→04/02 |   |  | BAE946A  | 7.5 | 27  | 53 |   |  |     |  |        |  |        |  |
| 1.6  | 4 | 8V  | NFZ (TU5JP)                           |   |  | 65/88   | 04/96→10/00 |   |  | BAE945A  | 7.5 | 27  | 53 |   |  |     |  |        |  |        |  |
| <b>306 Hatchback (7A, 7C, N3, N5)</b>  |   |   |                                       |   |  |   |             |   |  |          |     |   |    |   |  |     |  |        |  |        |  |
| 1.4  | 4 | 8V  | KDX (TU3MC), KFW (TU3JP), KFX (TU3JP) |   |  | 55/75   | 05/93→06/00 |   |  | BAE945A  | 7.5 | 27  | 53 |   |  |     |  |        |  |        |  |
| 1.4  | 4 | 8V  | KDX (TU3MC), KFW (TU3JP), KFX (TU3JP) |   |  | 55/75   | 07/00→05/01 |   |  | BAE946A  | 7.5 | 27  | 53 |   |  |     |  |        |  |        |  |
| 1.6  | 4 | 8V  | NFT                                   |   |  | 72/98   | 10/00→05/01 |   |  | BAE946A  | 7.5 | 27  | 53 |   |  |     |  |        |  |        |  |
| 1.6  | 4 | 8V  | NFZ (TU5JP)                           |   |  | 65/88   | 05/93→10/00 |   |  | BAE945A  | 7.5 | 27  | 53 |   |  |     |  |        |  |        |  |
| <b>307 (3A/C)</b>  |   |   |                                       |   |  |   |             |   |  |          |     |   |    |   |  |     |  |        |  |        |  |
| 1.4  | 4 | 8V  | KFW (TU3JP)                           |   |  | 55/75   | 08/00→      |   |  | BAE946A  | 7.5 | 27  | 53 |   |  |     |  |        |  |        |  |
| 1.6 16V  | 4 | 16V   | NFU (TU5JP4)                          |   |  | 80/109  | 08/00→      |   |  | BAE946A  | 7.5 | 27  | 53 |   |  |     |  |        |  |        |  |
| <b>307 Break (3E)</b>  |   |   |                                       |   |  |   |             |   |  |          |     |   |    |   |  |     |  |        |  |        |  |
| 1.4 16V  | 4 | 16V   | KFU (ET3J4)                           |   |  | 65/88   | 11/03→      |   |  | BAE946A  | 7.5 | 27  | 53 |   |  |     |  |        |  |        |  |
| 1.6 16V  | 4 | 16V   | NFU (TU5JP4)                          |   |  | 80/109  | 03/02→      |   |  | BAE946A  | 7.5 | 27  | 53 |   |  |     |  |        |  |        |  |
| <b>307 CC (3B)</b>   |   |   |                                       |   |  |   |             |   |  |          |     |   |    |   |  |     |  |        |  |        |  |
| 1.6 16V  | 4 | 16V   | NFU (TU5JP4)                          |   |  | 80/109  | 03/05→      |   |  | BAE946A  | 7.5 | 27  | 53 |   |  |     |  |        |  |        |  |
| <b>307 SW (3H)</b>   |   |   |                                       |   |  |   |             |   |  |          |     |   |    |   |  |     |  |        |  |        |  |
| 1.4 16V  | 4 | 16V   | KFU (ET3J4)                           |   |  | 65/88   | 11/03→      |   |  | BAE945A  | 7.5 | 27  | 53 |   |  |     |  |        |  |        |  |
| 1.6 16V  | 4 | 16V   | NFU (TU5JP4)                          |   |  | 80/109  | 03/02→      |   |  | BAE946A  | 7.5 | 27  | 53 |   |  |     |  |        |  |        |  |
| <b>309 (10C, 10A)</b>  |   |   |                                       |   |  |   |             |   |  |          |     |   |    |   |  |     |  |        |  |        |  |
| 1.4  | 4 | 8V  | KDY (TU3M), KDZ (TU3M)                | ✓   |  | 55/75   | 03/89→07/89 |   |  | BAE507AK | 7.5 | 26  | 90 |   |  |     |  |        |  |        |  |
| <b>309 I (10C, 10A)</b>  |   |   |                                       |   |  |   |             |   |  |          |     |   |    |   |  |     |  |        |  |        |  |
| 1.3  | 4 | 8V  | G1A                                   | ✓   |  | 47/64   | 10/85→07/89 |   |  | BAE507AK | 7.5 | 26  | 90 |   |  |     |  |        |  |        |  |
| <b>405 (15B)</b>   |   |   |                                       |   |  |   |             |   |  |          |     |   |    |   |  |     |  |        |  |        |  |
| 1.4  | 4 | 8V  | TU3                                   | ✓   |  | 47/64   | 01/87→07/92 |   |  | BAE507AK | 7.5 | 26  | 90 |   |  |     |  |        |  |        |  |
| <b>405 Estate (15B)</b>  |   |   |                                       |   |  |   |             |   |  |          |     |   |    |   |  |     |  |        |  |        |  |
| 1.4  | 4 | 8V  | TU3                                   | ✓   |  | 47/64   | 05/88→07/92 |   |  | BAE507AK | 7.5 | 26  | 90 |   |  |     |  |        |  |        |  |
| <b>405 Mk II (4B)</b>  |   |   |                                       |   |  |   |             |   |  |          |     |   |    |   |  |     |  |        |  |        |  |
| 2.0 T 16 X4  | 4 |   | RGZ (XU10J4TE/Z)                      |   |  | 144/196   | 08/92→10/95 |   |  | BAE700AK | 6.2 | 27  | 30 |   |  |     |  |        |  |        |  |
| <b>406 (8B)</b>  |   |   |                                       |   |  |   |             |   |  |          |     |   |    |   |  |     |  |        |  |        |  |
| 1.6  | 4 | 8V  | BFZ (XU5JP)                           |   |  | 65/88   | 11/95→06/00 |   |  | BAE945A  | 7.5 | 27  | 53 |   |  |     |  |        |  |        |  |
| 1.6  | 4 | 8V  | BFZ (XU5JP)                           |   |  | 65/88   | 07/00→05/04 |   |  | BAE946A  | 7.5 | 27  | 53 |   |  |     |  |        |  |        |  |
| <b>605 (6B)</b>  |   |   |                                       |   |  |   |             |   |  |          |     |   |    |   |  |     |  |        |  |        |  |
| 2.0  | 4 | 8V  | RFZ (XU10J2Z)                         | ✓   |  | 89/121  | 06/89→09/99 |   |  | BAE507BK | 7.5 | 26  | 90 |   |  |     |  |        |  |        |  |
| <b>1007</b>  |   |   |                                       |   |  |   |             |   |  |          |     |   |    |   |  |     |  |        |  |        |  |
| 1.4  | 4 |   | KFV (TU3JP)                           |   |  | 55/75   | 04/05→      |   |  | BAE946A  | 7.5 | 27  | 53 |   |  |     |  |        |  |        |  |
| <b>PARTNER Combispace (5F)</b>   |   |   |                                       |   |  |   |             |   |  |          |     |   |    |   |  |     |  |        |  |        |  |
| 1.1  | 4 | 8V  | HDZ (TU1M), HFX (TU1JP)               |   |  | 44/60   | 06/96→06/00 |   |  | BAE945A  | 7.5 | 27  | 53 |   |  |     |  |        |  |        |  |
| 1.1  | 4 | 8V  | HDZ (TU1M), HFX (TU1JP)               |   |  | 44/60   | 07/00→      |   |  | BAE946A  | 7.5 | 27  | 53 |   |  |     |  |        |  |        |  |
| 1.4  | 4 | 8V  | KFW (TU3JP), KFX (TU3JP)              |   |  | 55/75   | 06/96→06/00 |   |  | BAE945A  | 7.5 | 27  | 53 |   |  |     |  |        |  |        |  |
| 1.4  | 4 | 8V  | KFW (TU3JP), KFX (TU3JP)              |   |  | 55/75   | 07/00→      |   |  | BAE946A  | 7.5 | 27  | 53 |   |  |     |  |        |  |        |  |
| <b>PEUGEOT</b>    |   |   |                                       |   |  |   |             |   |  |          |     |   |    |   |  |     |  |        |  |        |  |
| <b>PARTNER Box (5)</b>   |   |   |                                       |   |  |   |             |   |  |          |     |   |    |   |  |     |  |        |  |        |  |
| 1.1  | 4 | 8V  | HDZ (TU1M)                            |   |  | 44/60   | 06/96→06/00 |   |  | BAE945A  | 7.5 | 27  | 53 |   |  |     |  |        |  |        |  |
| 1.1  | 4 | 8V  | HDZ (TU1M)                            |   |  | 44/60   | 07/00→      |   |  | BAE946A  | 7.5 | 27  | 53 |   |  |     |  |        |  |        |  |
| 1.4  | 4 | 8V  | KFX (TU3JP)                           |   |  | 55/75   | 06/96→06/00 |   |  | BAE945A  | 7.5 | 27  | 53 |   |  |     |  |        |  |        |  |
| 1.4  | 4 | 8V  | KFX (TU3JP)                           |   |  | 55/75   | 07/00→      |   |  | BAE946A  | 7.5 | 27  | 53 |   |  |     |  |        |  |        |  |
| 1.4 BiFuel   | 4 | 8V  | KFW (TU3JP)                           |   |  | 55/75   | 04/03→      |   |  | BAE946A  | 7.5 | 27  | 53 |   |  |     |  |        |  |        |  |
| <b>RENAULT</b>    |   |   |                                       |   |  |   |             |   |  |          |     |   |    |   |  |     |  |        |  |        |  |
| <b>19 Mk II (B/C53 )</b>   |   |   |                                       |   |  |   |             |   |  |          |     |   |    |   |  |     |  |        |  |        |  |
| 1.8 (S/353F, B/C538)   | 4 | 8V  | F3P 682, F3P 765                      | ✓   |  | 79/107  | 05/94→12/95 |   |  | BAE504L  |     | 28  | 90 |   |  |     |  |        |  |        |  |
| <b>19 Mk II Saloon (L53 )</b>  |   |   |                                       |   |  |   |             |   |  |          |     |   |    |   |  |     |  |        |  |        |  |
| 1.8 (L53V, L538)   | 4 | 8V  | F3P 682                               | ✓   |  | 79/107  | 05/94→12/95 |   |  | BAE504L  |     | 28  | 90 |   |  |     |  |        |  |        |  |

RENAULT



kW / BHP



Amp

Out  
kVOut  
mJ

## ... RENAULT

**AVANTIME (DE0 )**

|               |   |     |                  |         |             |         |     |    |    |
|---------------|---|-----|------------------|---------|-------------|---------|-----|----|----|
| 2.0 16V Turbo | 4 | 16V | F4R 760, F4R 761 | 120/163 | 11/01→05/03 | BAE409A | 7.5 | 26 | 37 |
|---------------|---|-----|------------------|---------|-------------|---------|-----|----|----|

**CLIO I (B/C57 , 5/357 )**

|                |   |    |         |       |             |         |  |    |    |
|----------------|---|----|---------|-------|-------------|---------|--|----|----|
| 1.2 (B/C/S577) | 4 | 8V | C3G 720 | 40/54 | 01/96→12/96 | BAE504L |  | 28 | 90 |
|----------------|---|----|---------|-------|-------------|---------|--|----|----|

**CLIO Mk II (BB0/1/2 , CB0/1/2 )**

|                  |   |     |                  |       |        |         |     |    |    |
|------------------|---|-----|------------------|-------|--------|---------|-----|----|----|
| 1.2 16V (B/CB05) | 4 | 16V | D4F 712, D4F 714 | 55/75 | 06/01→ | BAE947A | 7.5 | 25 | 40 |
|------------------|---|-----|------------------|-------|--------|---------|-----|----|----|

|                  |   |     |                  |       |             |         |     |    |    |
|------------------|---|-----|------------------|-------|-------------|---------|-----|----|----|
| 1.4 16V (B/CB0L) | 4 | 16V | K4J 712, K4J 713 | 70/95 | 10/99→08/00 | BAE409A | 7.5 | 26 | 37 |
|------------------|---|-----|------------------|-------|-------------|---------|-----|----|----|

|                  |   |     |                           |       |        |         |     |    |    |
|------------------|---|-----|---------------------------|-------|--------|---------|-----|----|----|
| 1.4 16V (B/CBOP) | 4 | 16V | K4J 700, K4J 712, K4J 713 | 72/98 | 08/00→ | BAE409A | 7.5 | 26 | 37 |
|------------------|---|-----|---------------------------|-------|--------|---------|-----|----|----|

|                      |   |     |                  |        |        |         |     |    |    |
|----------------------|---|-----|------------------|--------|--------|---------|-----|----|----|
| 1.6 16V (CBOT, CB0H) | 4 | 16V | K4M 708, K4M 748 | 79/107 | 09/98→ | BAE409A | 7.5 | 26 | 37 |
|----------------------|---|-----|------------------|--------|--------|---------|-----|----|----|

|                      |   |     |         |         |        |         |     |    |    |
|----------------------|---|-----|---------|---------|--------|---------|-----|----|----|
| 2.0 16V Sport (CBOM) | 4 | 16V | F4R 730 | 124/168 | 02/00→ | BAE409A | 7.5 | 26 | 37 |
|----------------------|---|-----|---------|---------|--------|---------|-----|----|----|

**CLIO III (BR0/1, CR0/1)**

|         |   |     |         |       |        |         |     |    |    |
|---------|---|-----|---------|-------|--------|---------|-----|----|----|
| 1.4 16V | 4 | 16V | K4J 780 | 72/98 | 06/05→ | BAE409A | 7.5 | 26 | 37 |
|---------|---|-----|---------|-------|--------|---------|-----|----|----|

|         |   |     |                  |        |        |         |     |    |    |
|---------|---|-----|------------------|--------|--------|---------|-----|----|----|
| 1.6 16V | 4 | 16V | K4M 800, K4M 801 | 82/112 | 06/05→ | BAE409A | 7.5 | 26 | 37 |
|---------|---|-----|------------------|--------|--------|---------|-----|----|----|

|         |   |     |         |       |        |         |     |    |    |
|---------|---|-----|---------|-------|--------|---------|-----|----|----|
| 1.6 16V | 4 | 16V | K4M 804 | 65/88 | 06/05→ | BAE409A | 7.5 | 26 | 37 |
|---------|---|-----|---------|-------|--------|---------|-----|----|----|

|               |   |     |         |         |        |         |     |    |    |
|---------------|---|-----|---------|---------|--------|---------|-----|----|----|
| 2.0 16V Sport | 4 | 16V | F4R 830 | 145/197 | 02/06→ | BAE409A | 7.5 | 26 | 37 |
|---------------|---|-----|---------|---------|--------|---------|-----|----|----|

**ESPACE Mk II (J/S63 )**

|            |   |    |         |        |             |          |     |    |    |
|------------|---|----|---------|--------|-------------|----------|-----|----|----|
| 2.0 (JEOA) | 4 | 8V | J7R 768 | 76/103 | 01/91→10/96 | BAE801AK | 6.0 | 26 | 42 |
|------------|---|----|---------|--------|-------------|----------|-----|----|----|

**ESPACE Mk III (JEO )**

|     |   |  |                  |         |             |         |     |    |    |
|-----|---|--|------------------|---------|-------------|---------|-----|----|----|
| 2.0 | 4 |  | F4R 701, F4R 700 | 102/139 | 09/01→10/02 | BAE409A | 7.5 | 26 | 37 |
|-----|---|--|------------------|---------|-------------|---------|-----|----|----|

|            |   |    |   |        |             |          |     |    |    |
|------------|---|----|---|--------|-------------|----------|-----|----|----|
| 2.0 (JEOA) | 4 | 8V | F3R 728, F3R 729, F3R 742, F3R 768, F3R 769 | 84/114 | 11/96→10/00 | BAE801AK | 6.0 | 26 | 42 |
|------------|---|----|---|--------|-------------|----------|-----|----|----|

|            |   |    |   |        |             |          |     |    |    |
|------------|---|----|---|--------|-------------|----------|-----|----|----|
| 2.0 (JEOA) | 4 | 8V | F3R 728, F3R 729, F3R 742, F3R 768, F3R 769 | 84/114 | 11/96→10/00 | BAE801EK | 6.0 | 26 | 42 |
|------------|---|----|---|--------|-------------|----------|-----|----|----|

|                            |   |     |                  |         |             |         |     |    |    |
|----------------------------|---|-----|------------------|---------|-------------|---------|-----|----|----|
| 2.0 16V (JEON, JEOL, JEO2) | 4 | 16V | F4R 700, F4R 701 | 103/140 | 10/98→10/02 | BAE409A | 7.5 | 26 | 37 |
|----------------------------|---|-----|------------------|---------|-------------|---------|-----|----|----|

|            |   |     |         |         |             |          |     |    |    |
|------------|---|-----|---------|---------|-------------|----------|-----|----|----|
| 3.0 (JEOD) | 6 | 12V | Z7X 775 | 123/167 | 11/96→10/98 | BAE801AK | 6.0 | 26 | 42 |
|------------|---|-----|---------|---------|-------------|----------|-----|----|----|

|            |   |     |         |         |             |          |     |    |    |
|------------|---|-----|---------|---------|-------------|----------|-----|----|----|
| 3.0 (JEOD) | 6 | 12V | Z7X 775 | 123/167 | 11/96→10/98 | BAE801CK | 6.0 | 26 | 42 |
|------------|---|-----|---------|---------|-------------|----------|-----|----|----|

**ESPACE Mk IV (JK0/1 )**

|     |   |  |         |         |        |         |     |    |    |
|-----|---|--|---------|---------|--------|---------|-----|----|----|
| 2.0 | 4 |  | F4R 897 | 125/170 | 04/05→ | BAE409A | 7.5 | 26 | 37 |
|-----|---|--|---------|---------|--------|---------|-----|----|----|

|              |   |  |                  |         |        |         |     |    |    |
|--------------|---|--|------------------|---------|--------|---------|-----|----|----|
| 2.0 (JK0KA6) | 4 |  | F4R 790, F4R 791 | 100/136 | 11/02→ | BAE409A | 7.5 | 26 | 37 |
|--------------|---|--|------------------|---------|--------|---------|-----|----|----|

|  |   |     |                           |         |        |         |     |    |    |
|--|---|-----|---------------------------|---------|--------|---------|-----|----|----|
| 2.0 Turbo (JK0BA6, JK0BC6, JK0BAB, JK0BCB) | 4 | 16V | F4R 795, F4R 794, F4R 797 | 120/163 | 11/02→ | BAE409A | 7.5 | 26 | 37 |
|--|---|-----|---------------------------|---------|--------|---------|-----|----|----|

**GRAND SCENIC (JMO/1 )**

|     |   |  |                  |        |        |         |     |    |    |
|-----|---|--|------------------|--------|--------|---------|-----|----|----|
| 1.6 | 4 |  | K4M 761, K4M 782 | 83/113 | 04/04→ | BAE409A | 7.5 | 26 | 37 |
|-----|---|--|------------------|--------|--------|---------|-----|----|----|

|     |   |  |                  |        |        |         |     |    |    |
|-----|---|--|------------------|--------|--------|---------|-----|----|----|
| 2.0 | 4 |  | F4R 771, F4R 770 | 99/135 | 04/04→ | BAE409A | 7.5 | 26 | 37 |
|-----|---|--|------------------|--------|--------|---------|-----|----|----|

|     |   |  |         |         |        |         |     |    |    |
|-----|---|--|---------|---------|--------|---------|-----|----|----|
| 2.0 | 4 |  | F4R 776 | 120/163 | 04/04→ | BAE409A | 7.5 | 26 | 37 |
|-----|---|--|---------|---------|--------|---------|-----|----|----|

**KANGOO (KCO/1 )**

|  |   |     |                           |       |        |         |     |    |    |
|--|---|-----|---------------------------|-------|--------|---------|-----|----|----|
| 1.2 16V (KCO3, KCO5, KCO6, KCO7, KCOV) | 4 | 16V | D4F 712, D4F 714, D4F 716 | 55/75 | 06/01→ | BAE947A | 7.5 | 25 | 40 |
|--|---|-----|---------------------------|-------|--------|---------|-----|----|----|

|         |   |     |         |       |        |         |     |    |    |
|---------|---|-----|---------|-------|--------|---------|-----|----|----|
| 1.6 16V | 4 | 16V | K4M 752 | 70/95 | 06/01→ | BAE409A | 7.5 | 26 | 37 |
|---------|---|-----|---------|-------|--------|---------|-----|----|----|

|                                |   |     |                           |       |        |         |     |    |    |
|--------------------------------|---|-----|---------------------------|-------|--------|---------|-----|----|----|
| 1.6 16V 4x4 (KCOP, KCO5, KCOL) | 4 | 16V | K4M 750, K4M 752, K4M 753 | 70/95 | 10/01→ | BAE409A | 7.5 | 26 | 37 |
|--------------------------------|---|-----|---------------------------|-------|--------|---------|-----|----|----|

**LAGUNA (B56 , 556 )**

|                      |   |     |                  |        |             |         |     |    |    |
|----------------------|---|-----|------------------|--------|-------------|---------|-----|----|----|
| 1.6 16V (B568, B561) | 4 | 16V | K4M 720, K4M 724 | 79/107 | 11/97→03/01 | BAE409A | 7.5 | 26 | 37 |
|----------------------|---|-----|------------------|--------|-------------|---------|-----|----|----|

|                |   |    |                  |       |             |          |     |    |    |
|----------------|---|----|------------------|-------|-------------|----------|-----|----|----|
| 1.8 (B56S/T/O) | 4 | 8V | F3P 670, F3P 678 | 66/90 | 08/95→03/01 | BAE801AK | 6.0 | 26 | 42 |
|----------------|---|----|------------------|-------|-------------|----------|-----|----|----|

|                |   |    |                  |       |             |          |     |    |    |
|----------------|---|----|------------------|-------|-------------|----------|-----|----|----|
| 1.8 (B56S/T/O) | 4 | 8V | F3P 670, F3P 678 | 66/90 | 08/95→03/01 | BAE801EK | 6.0 | 26 | 42 |
|----------------|---|----|------------------|-------|-------------|----------|-----|----|----|

|                      |   |     |         |        |             |         |     |    |    |
|----------------------|---|-----|---------|--------|-------------|---------|-----|----|----|
| 1.8 16V (B563, B564) | 4 | 16V | F4P 760 | 88/120 | 04/98→03/01 | BAE409A | 7.5 | 26 | 37 |
|----------------------|---|-----|---------|--------|-------------|---------|-----|----|----|

|                |   |    |                  |        |             |          |     |    |    |
|----------------|---|----|------------------|--------|-------------|----------|-----|----|----|
| 2.0 (B56C/H/N) | 4 | 8V | F3R 722, F3R 723 | 83/113 | 11/93→03/01 | BAE801AK | 6.0 | 26 | 42 |
|----------------|---|----|------------------|--------|-------------|----------|-----|----|----|

|                  |   |     |         |         |             |         |     |    |    |
|------------------|---|-----|---------|---------|-------------|---------|-----|----|----|
| 2.0 16V (556A/B) | 4 | 16V | F4R 780 | 103/140 | 09/99→03/01 | BAE409A | 7.5 | 26 | 37 |
|------------------|---|-----|---------|---------|-------------|---------|-----|----|----|

|                    |   |     |                  |         |             |          |     |    |    |
|--------------------|---|-----|------------------|---------|-------------|----------|-----|----|----|
| 3.0 (B56E/R, B565) | 6 | 12V | Z7X 760, Z7X 765 | 123/167 | 11/93→03/01 | BAE801AK | 6.0 | 26 | 42 |
|--------------------|---|-----|------------------|---------|-------------|----------|-----|----|----|

|                    |   |     |                  |         |             |          |     |    |    |
|--------------------|---|-----|------------------|---------|-------------|----------|-----|----|----|
| 3.0 (B56E/R, B565) | 6 | 12V | Z7X 760, Z7X 765 | 123/167 | 11/93→03/01 | BAE801BK | 6.0 | 26 | 42 |
|--------------------|---|-----|------------------|---------|-------------|----------|-----|----|----|

**LAGUNA Estate (K56 )**

|                |   |    |                  |       |             |          |     |    |    |
|----------------|---|----|------------------|-------|-------------|----------|-----|----|----|
| 1.8 (K56S/T/O) | 4 | 8V | F3P 678, F3P 670 | 66/90 | 09/95→03/01 | BAE801AK | 6.0 | 26 | 42 |
|----------------|---|----|------------------|-------|-------------|----------|-----|----|----|

|              |   |    |                  |        |             |          |     |    |    |
|--------------|---|----|------------------|--------|-------------|----------|-----|----|----|
| 2.0 (K56C/H) | 4 | 8V | F3R 722, F3R 723 | 83/113 | 09/95→03/01 | BAE801AK | 6.0 | 26 | 42 |
|--------------|---|----|------------------|--------|-------------|----------|-----|----|----|

**LAGUNA Grandtour (K56 )**

|                |   |     |                  |        |             |         |     |    |    |
|----------------|---|-----|------------------|--------|-------------|---------|-----|----|----|
| 1.6 16V (K568) | 4 | 16V | K4M 720, K4M 724 | 79/107 | 11/97→03/01 | BAE409A | 7.5 | 26 | 37 |
|----------------|---|-----|------------------|--------|-------------|---------|-----|----|----|

|                      |   |     |         |        |             |         |     |    |    |
|----------------------|---|-----|---------|--------|-------------|---------|-----|----|----|
| 1.8 16V (K563, K564) | 4 | 16V | F4P 760 | 88/120 | 04/98→03/01 | BAE409A | 7.5 | 26 | 37 |
|----------------------|---|-----|---------|--------|-------------|---------|-----|----|----|

**LAGUNA II (BGO/1 )**

|         |   |     |         |        |        |         |     |    |    |
|---------|---|-----|---------|--------|--------|---------|-----|----|----|
| 1.6 16V | 4 | 16V | K4M 716 | 82/112 | 02/05→ | BAE409A | 7.5 | 26 | 37 |
|---------|---|-----|---------|--------|--------|---------|-----|----|----|

|                      |   |     |                  |        |        |         |     |    |    |
|----------------------|---|-----|------------------|--------|--------|---------|-----|----|----|
| 1.6 16V (BGOA, BGOL) | 4 | 16V | K4M 710, K4M 711 | 79/107 | 03/01→ | BAE409A | 7.5 | 26 | 37 |
|----------------------|---|-----|------------------|--------|--------|---------|-----|----|----|

|                            |   |     |   |        |        |         |     |    |    |
|----------------------------|---|-----|---|--------|--------|---------|-----|----|----|
| 1.8 16V (BGO6, BGOJ, BGOM) | 4 | 16V | F4P 774, F4P 770, F4P 773, F4P 771, F4P 775 | 85/116 | 03/01→ | BAE409A | 7.5 | 26 | 37 |
|----------------------------|---|-----|---|--------|--------|---------|-----|----|----|

|                      |   |     |                  |        |        |         |     |    |    |
|----------------------|---|-----|------------------|--------|--------|---------|-----|----|----|
| 1.8 16V (BGOB, BGOM) | 4 | 16V | F4P 770, F4P 773 | 88/120 | 03/01→ | BAE409A | 7.5 | 26 | 37 |
|----------------------|---|-----|------------------|--------|--------|---------|-----|----|----|

|                      |   |     |                  |        |        |         |     |    |    |
|----------------------|---|-----|------------------|--------|--------|---------|-----|----|----|
| 1.8 16V (BGOC, BGOV) | 4 | 16V | F4P 774, F4P 770 | 89/121 | 03/01→ | BAE409A | 7.5 | 26 | 37 |
|----------------------|---|-----|------------------|--------|--------|---------|-----|----|----|

|         |   |     |  |         |        |         |     |    |    |
|---------|---|-----|--|---------|--------|---------|-----|----|----|
| 2.0 16V | 4 | 16V |  | 150/204 | 01/05→ | BAE409A | 7.5 | 26 | 37 |
|---------|---|-----|--|---------|--------|---------|-----|----|----|



KW / BHP



Amp

Out  
kV

Out  
mJ

**... RENAULT**



**... LAGUNA II (BGO/1 )**

|  |   |     |                                    |         |         |         |     |    |    |
|--|---|-----|------------------------------------|---------|---------|---------|-----|----|----|
| 2.0 16V (BG00, BG0K, BG0P, BG0W)       | 4 | 16V | F4R 713, F4R 715, F4R 712, F4R 714 | 99/135  | 08/02 → | BAE409A | 7.5 | 26 | 37 |
| 2.0 16V Turbo (BG0S, BG0Z, BG1L, BG1M) | 4 | 16V | F4R 764, F4R 787, F4R 786, F4R 765 | 120/163 | 01/03 → | BAE409A | 7.5 | 26 | 37 |

**LAGUNA II Grandtour (KG0/1 )**

|                      |   |     |                  |        |         |         |     |    |    |
|----------------------|---|-----|------------------|--------|---------|---------|-----|----|----|
| 1.6 16V (KG0A, KG0L) | 4 | 16V | K4M 710, K4M 711 | 79/107 | 03/01 → | BAE409A | 7.5 | 26 | 37 |
| 1.8 16V (KG0B, KG0M) | 4 | 16V | F4P 770, F4P 773 | 88/120 | 03/01 → | BAE409A | 7.5 | 26 | 37 |

**LAGUNA II Sport Tourer (KG0/1 )**

|  |   |     |                                    |         |         |         |     |    |    |
|--|---|-----|------------------------------------|---------|---------|---------|-----|----|----|
| 1.6 16V                                | 4 | 16V | K4M 716                            | 82/112  | 02/05 → | BAE409A | 7.5 | 26 | 37 |
| 1.8 16V                                | 4 | 16V | F4P 774, F4P 770                   | 89/121  | 03/01 → | BAE409A | 7.5 | 26 | 37 |
| 1.8 16V (KG0J)                         | 4 | 16V | F4P 774, F4P 773, F4P 771          | 85/116  | 03/01 → | BAE409A | 7.5 | 26 | 37 |
| 2.0 16V                                | 4 | 16V |                                    | 150/204 | 01/05 → | BAE409A | 7.5 | 26 | 37 |
| 2.0 16V (KG00, KG0K, KG0W)             | 4 | 16V | F4R 713, F4R 715, F4R 712, F4R 714 | 99/135  | 08/02 → | BAE409A | 7.5 | 26 | 37 |
| 2.0 16V Turbo (KG0S, KG0Z, KG1L, KG1M) | 4 | 16V | F4R 764, F4R 787, F4R 786, F4R 765 | 120/163 | 01/03 → | BAE409A | 7.5 | 26 | 37 |

**MEGANE Cabriolet (EA0/1 )**

|                                  |   |     |                           |         |               |          |     |    |    |
|----------------------------------|---|-----|---------------------------|---------|---------------|----------|-----|----|----|
| 1.4 16V (EA0D, EA0H, EA0W, EA10) | 4 | 16V | K4J 714, K4J 750          | 70/95   | 03/99 →       | BAE409A  | 7.5 | 26 | 37 |
| 1.6 16V (EA0B, EA04, EA11)       | 4 | 16V | K4M 700, K4M 701, K4M 708 | 79/107  | 03/99 →       | BAE409A  | 7.5 | 26 | 37 |
| 2.0 16V (EA0H)                   | 4 | 16V | F7R 710, F7R 714          | 108/147 | 10/96 → 11/99 | BAE801AK | 6.0 | 26 | 42 |
| 2.0 i (EA0G)                     | 4 | 8V  | F3R 791, F3R 796          | 80/109  | 03/99 →       | BAE801AK | 6.0 | 26 | 42 |

**MEGANE Classic (LA0/1 )**

|  |   |     |                           |        |         |          |     |    |    |
|--|---|-----|---------------------------|--------|---------|----------|-----|----|----|
| 1.4 16V (LA0D, LA0H, LA0W, LA10)       | 4 | 16V | K4J 714, K4J 750          | 70/95  | 03/99 → | BAE409A  | 7.5 | 26 | 37 |
| 1.6 16V (LA04, LA11, LA0B, LA1C, LA1J) | 4 | 16V | K4M 700, K4M 701, K4M 708 | 79/107 | 03/99 → | BAE409A  | 7.5 | 26 | 37 |
| 1.8 16V (LA06, LA12, LA1A, LA1M, LA1R) | 4 | 16V | F4P 720, F4P 722          | 85/115 | 01/01 → | BAE409A  | 7.5 | 26 | 37 |
| 2.0 i (LA07, LA0G)                     | 4 | 8V  | F3R 750, F3R 751          | 84/114 | 09/96 → | BAE801EK | 6.0 | 26 | 42 |

**MEGANE Coach (DA0/1 )**

|                                  |   |     |                           |         |         |          |     |    |    |
|----------------------------------|---|-----|---------------------------|---------|---------|----------|-----|----|----|
| 1.4 16V (DA0D, DA0H, DA0W, DA10) | 4 | 16V | K4J 714, K4J 750          | 70/95   | 03/99 → | BAE409A  | 7.5 | 26 | 37 |
| 1.6 16V (DA0B, DA04, DA11)       | 4 | 16V | K4M 700, K4M 701, K4M 708 | 79/107  | 03/99 → | BAE409A  | 7.5 | 26 | 37 |
| 2.0 16V                          | 4 |     |                           | 102/139 | 01/02 → | BAE409A  | 7.5 | 26 | 37 |
| 2.0 i (DA0G)                     | 4 | 8V  | F3R 750, F3R 751          | 84/114  | 03/96 → | BAE801AK | 6.0 | 26 | 42 |

**MEGANE Grandtour (KA0/1 )**

|  |   |     |                                    |        |         |         |     |    |    |
|--|---|-----|------------------------------------|--------|---------|---------|-----|----|----|
| 1.4 16V (KA0D, KA0H, KA0W, KA10)       | 4 | 16V | K4J 714, K4J 750                   | 70/95  | 03/99 → | BAE409A | 7.5 | 26 | 37 |
| 1.6 16V (KA0B, KA04, KA11)             | 4 | 16V | K4M 700, K4M 701, K4M 704, K4M 708 | 79/107 | 03/99 → | BAE409A | 7.5 | 26 | 37 |
| 1.8 16V (KA0S, KA12, KA1A, KA1M, KA1R) | 4 | 16V | F4P 720, F4P 722                   | 85/115 | 01/01 → | BAE409A | 7.5 | 26 | 37 |

**MEGANE I (BA0/1 )**

|  |   |     |                                    |        |         |          |     |    |    |
|--|---|-----|------------------------------------|--------|---------|----------|-----|----|----|
| 1.4 16V (BA0D, BA0H, BA0W, BA10)       | 4 | 16V | K4J 714, K4J 750                   | 70/95  | 03/99 → | BAE409A  | 7.5 | 26 | 37 |
| 1.6 16V (BA11, BA04, BA0B, BA1J)       | 4 | 16V | K4M 700, K4M 701, K4M 704, K4M 708 | 79/107 | 03/99 → | BAE409A  | 7.5 | 26 | 37 |
| 1.8 16V (BA06, BA12, BA1A, BA1M, BA1R) | 4 | 16V | F4P 720, F4P 722                   | 85/115 | 01/01 → | BAE409A  | 7.5 | 26 | 37 |
| 2.0 i (BA0G)                           | 4 | 8V  | F3R 751, F3R 750                   | 84/114 | 01/96 → | BAE801AK | 6.0 | 26 | 42 |

**MEGANE II (BMO/1 , CMO/1 )**

|                      |   |     |         |         |         |         |     |    |    |
|----------------------|---|-----|---------|---------|---------|---------|-----|----|----|
| 1.4 16V (BMOB, CMOB) | 4 | 16V | K4J 730 | 72/98   | 11/02 → | BAE409A | 7.5 | 26 | 37 |
| 1.6 16V (BMOC, CMOC) | 4 | 16V | K4M 760 | 83/113  | 11/02 → | BAE409A | 7.5 | 26 | 37 |
| 2.0 16V (BMOU, CMOU) | 4 | 16V | F4R 770 | 99/135  | 11/02 → | BAE409A | 7.5 | 26 | 37 |
| 2.0 16V Turbo        | 4 | 16V | F4R 776 | 120/163 | 05/04 → | BAE409A | 7.5 | 26 | 37 |
| 2.0 Renault Sport    | 4 |     |         | 165/224 | 05/04 → | BAE409A | 7.5 | 26 | 37 |

**MEGANE II Coupé-Cabriolet (EMO/1 )**

|               |   |     |         |         |         |         |     |    |    |
|---------------|---|-----|---------|---------|---------|---------|-----|----|----|
| 1.6           | 4 |     |         | 83/113  | 09/03 → | BAE409A | 7.5 | 26 | 37 |
| 2.0           | 4 |     |         | 99/135  | 09/03 → | BAE409A | 7.5 | 26 | 37 |
| 2.0 16V Turbo | 4 | 16V | F4R 776 | 120/163 | 05/04 → | BAE409A | 7.5 | 26 | 37 |

**MEGANE II Saloon (LMO/1 )**

|     |   |  |  |        |         |         |     |    |    |
|-----|---|--|--|--------|---------|---------|-----|----|----|
| 1.4 | 4 |  |  | 72/98  | 09/03 → | BAE409A | 7.5 | 26 | 37 |
| 1.6 | 4 |  |  | 83/113 | 09/03 → | BAE409A | 7.5 | 26 | 37 |
| 2.0 | 4 |  |  | 99/135 | 09/03 → | BAE409A | 7.5 | 26 | 37 |

**MEGANE II Station wagon (KMO/1 )**

|     |   |  |  |        |         |         |     |    |    |
|-----|---|--|--|--------|---------|---------|-----|----|----|
| 1.4 | 4 |  |  | 72/98  | 09/03 → | BAE409A | 7.5 | 26 | 37 |
| 1.6 | 4 |  |  | 83/113 | 09/03 → | BAE409A | 7.5 | 26 | 37 |
| 2.0 | 4 |  |  | 99/135 | 09/03 → | BAE409A | 7.5 | 26 | 37 |

RENAULT





kW / BHP



Amp

Out  
kVOut  
mJ
**... RENAULT**

**MEGANE Scenic (JAO/1 )**

|              |   |    |                  |        |             |          |     |    |    |
|--------------|---|----|------------------|--------|-------------|----------|-----|----|----|
| 2.0 i (JAOG) | 4 | 8V | F3R 751, F3R 750 | 84/114 | 01/97→09/99 | BAE801AK | 6.0 | 26 | 42 |
| 2.0 i (JAOG) | 4 | 8V | F3R 796          | 80/109 | 01/99→09/99 | BAE801EK | 6.0 | 26 | 42 |

**MODUS (F/JPO )**

|     |   |     |                  |        |        |         |     |    |    |
|-----|---|-----|------------------|--------|--------|---------|-----|----|----|
| 1.4 | 4 | 16V | K4J 770          | 72/98  | 12/04→ | BAE409A | 7.5 | 26 | 37 |
| 1.6 | 4 |     |                  | 65/88  | 12/04→ | BAE409A | 7.5 | 26 | 37 |
| 1.6 | 4 |     | K4M 790, K4M 791 | 82/111 | 12/04→ | BAE409A | 7.5 | 26 | 37 |

**SCÉNIC (JAO/1 )**

|                                  |   |     |                                    |         |        |         |     |    |    |
|----------------------------------|---|-----|------------------------------------|---------|--------|---------|-----|----|----|
| 1.4 16V (JAOD, JA1H, JaOW, JA1O) | 4 | 16V | K4J 714, K4J 750                   | 70/95   | 09/99→ | BAE409A | 7.5 | 26 | 37 |
| 1.6 16V (JA0B, JA04, JA11)       | 4 | 16V | K4M 700, K4M 701, K4M 704, K4M 708 | 79/107  | 09/99→ | BAE409A | 7.5 | 26 | 37 |
| 1.8 16V (JA12, JA1R, JA1M, JA1A) | 4 | 16V | F4P 720, F4P 722                   | 85/115  | 01/01→ | BAE409A | 7.5 | 26 | 37 |
| 2.0 16V (JA1B, JA1D)             | 4 | 16V | F4R 740, F4R 741                   | 102/139 | 07/00→ | BAE409A | 7.5 | 26 | 37 |
| 2.0 16V RX4                      | 4 | 16V | F4R 744                            | 102/139 | 06/00→ | BAE409A | 7.5 | 26 | 37 |

**SCÉNIC II (JMO/1 )**

|                        |   |     |                  |         |        |         |     |    |    |
|------------------------|---|-----|------------------|---------|--------|---------|-----|----|----|
| 1.4                    | 4 |     | K4J 730          | 72/98   | 06/03→ | BAE409A | 7.5 | 26 | 37 |
| 1.6 (JMOC, JMOJ, JM1B) | 4 | 16V | K4M 761, K4M 782 | 83/113  | 06/03→ | BAE409A | 7.5 | 26 | 37 |
| 2.0 (JM05, JM1N)       | 4 |     | F4R 771, F4R 770 | 99/135  | 06/03→ | BAE409A | 7.5 | 26 | 37 |
| 2.0 16V Turbo (JMOW)   | 4 | 16V | F4R 776          | 120/163 | 05/04→ | BAE409A | 7.5 | 26 | 37 |

**TWINGO (C06 )**

|                            |   |     |                  |       |             |         |     |    |    |
|----------------------------|---|-----|------------------|-------|-------------|---------|-----|----|----|
| 1.2 (C063, C064)           | 4 | 8V  | C3G 700, C3G 702 | 40/54 | 03/93→10/96 | BAE504L |     | 28 | 90 |
| 1.2 16V (C06C, C06D, C06K) | 4 | 16V | D4F 702, D4F 704 | 55/75 | 01/01→      | BAE947A | 7.5 | 25 | 40 |

**VEL SATIS (BJO )**

|                      |   |     |                  |         |        |         |     |    |    |
|----------------------|---|-----|------------------|---------|--------|---------|-----|----|----|
| 2.0 16 V Turbo       | 4 | 16V | F4R 766, F4R 767 | 125/170 | 04/04→ | BAE409A | 7.5 | 26 | 37 |
| 2.0 16V Turbo (BJOK) | 4 | 16V | F4R 762, F4R 763 | 120/163 | 06/02→ | BAE409A | 7.5 | 26 | 37 |

**RENAULT**

**CLIO I Box (S57 )**

|     |   |    |     |       |             |         |  |    |    |
|-----|---|----|-----|-------|-------------|---------|--|----|----|
| 1.2 | 4 | 8V | C3G | 40/54 | 06/94→02/98 | BAE504L |  | 28 | 90 |
|-----|---|----|-----|-------|-------------|---------|--|----|----|

**KANGOO Express (FC0/1 )**

|                                |   |     |                           |       |        |         |     |    |    |
|--------------------------------|---|-----|---------------------------|-------|--------|---------|-----|----|----|
| 1.2 16V (FC05)                 | 4 | 16V | D4F 712, D4F 714          | 55/75 | 10/01→ | BAE947A | 7.5 | 25 | 40 |
| 1.6 16V                        | 4 | 16V | K4M 752                   | 70/95 | 10/01→ | BAE409A | 7.5 | 26 | 37 |
| 1.6 16V 4x4 (FCOL, FCOP, FCOS) | 4 | 16V | K4M 750, K4M 752, K4M 753 | 70/95 | 10/01→ | BAE409A | 7.5 | 26 | 37 |

**TRAFIC Box (FL)**

|            |   |     |         |        |        |         |     |    |    |
|------------|---|-----|---------|--------|--------|---------|-----|----|----|
| 2.0 (FLOA) | 4 | 16V | F4R.720 | 88/120 | 03/01→ | BAE409A | 7.5 | 26 | 37 |
|------------|---|-----|---------|--------|--------|---------|-----|----|----|

**TRAFIC Bus (JL)**

|            |   |     |         |        |        |         |     |    |    |
|------------|---|-----|---------|--------|--------|---------|-----|----|----|
| 2.0 (JLOA) | 4 | 16V | F4R.720 | 88/120 | 03/01→ | BAE409A | 7.5 | 26 | 37 |
|------------|---|-----|---------|--------|--------|---------|-----|----|----|

**ROVER**

**45 (RT)**

|        |   |     |        |         |        |         |     |    |    |
|--------|---|-----|--------|---------|--------|---------|-----|----|----|
| 2.0 V6 | 6 | 24V | 20 K4F | 110/150 | 02/00→ | BAE403H | 7.5 | 27 | 42 |
|--------|---|-----|--------|---------|--------|---------|-----|----|----|

**45 Saloon (RT)**

|        |   |     |        |         |        |         |     |    |    |
|--------|---|-----|--------|---------|--------|---------|-----|----|----|
| 2.0 V6 | 6 | 24V | 20 K4F | 110/150 | 02/00→ | BAE403H | 7.5 | 27 | 42 |
|--------|---|-----|--------|---------|--------|---------|-----|----|----|

**75 (RJ)**

|        |   |     |        |         |             |         |     |    |    |
|--------|---|-----|--------|---------|-------------|---------|-----|----|----|
| 2.0 V6 | 6 | 24V | 20 K4F | 110/150 | 02/99→      | BAE403H | 7.5 | 27 | 42 |
| 2.5 V6 | 6 | 24V | KV 6   | 129/175 | 02/99→10/01 | BAE403H | 7.5 | 27 | 42 |

**75 Tourer (RJ)**

|        |   |     |        |         |        |         |     |    |    |
|--------|---|-----|--------|---------|--------|---------|-----|----|----|
| 2.0 V6 | 6 | 24V | 20 K4F | 110/149 | 08/01→ | BAE403H | 7.5 | 27 | 42 |
| 2.5 V6 | 6 | 24V | 25 K4F | 130/177 | 10/01→ | BAE403H | 7.5 | 27 | 42 |
| 2.5 V6 | 6 | 24V | KV 6   | 130/177 | 08/01→ | BAE403H | 7.5 | 27 | 42 |

**SEAT**

**ALHAMBRA (7V8, 7V9)**

|       |   |    |     |        |        |          |     |    |    |
|-------|---|----|-----|--------|--------|----------|-----|----|----|
| 2.0 i | 4 | 8V | ADY | 85/115 | 04/96→ | BAE851AE | 6.5 | 28 | 85 |
| 2.0 i | 4 | 8V | ATM | 85/115 | 04/96→ | BAE907AE | 7.5 | 33 | 85 |

**ALTEA (5P1)**

|     |   |    |               |        |        |          |     |    |    |
|-----|---|----|---------------|--------|--------|----------|-----|----|----|
| 1.6 | 4 | 8V | BGU, BSE, BSF | 75/102 | 03/04→ | BAE907AE | 7.5 | 33 | 85 |
|-----|---|----|---------------|--------|--------|----------|-----|----|----|



KW / BHP



Amp

Out  
kVOut  
mJ

## ... SEAT



## AROSA (6H)

|         |   |     |                              |        |        |          |     |    |    |
|---------|---|-----|------------------------------|--------|--------|----------|-----|----|----|
| 1.0     | 4 | 8V  | AER, AHT, ALD, ALL, ANV, AUC | 37/50  | 05/97→ | BAE961AE | 7.0 | 27 | 48 |
| 1.4     | 4 | 8V  | AEX, AKV, APQ                | 44/60  | 05/97→ | BAE851AE | 6.5 | 28 | 85 |
| 1.4     | 4 | 8V  | ANW, AKK, AUD                | 44/60  | 05/97→ | BAE907AE | 7.5 | 33 | 85 |
| 1.4 16V | 4 | 16V | AFK, ANM, AUB                | 74/101 | 01/00→ | BAE907AE | 7.5 | 33 | 85 |

## CORDOBA (6K2)

|         |   |     |                    |        |             |          |     |    |    |
|---------|---|-----|--------------------|--------|-------------|----------|-----|----|----|
| 1.0     | 4 | 8V  | ALD, ANV, AUC      | 37/50  | 06/99→10/02 | BAE907AE | 7.5 | 33 | 85 |
| 1.4     | 4 | 8V  | AMW, AKK           | 44/60  | 06/99→10/02 | BAE907AE | 7.5 | 33 | 85 |
| 1.4 16V | 4 | 16V | APE, AUA           | 55/75  | 05/00→10/02 | BAE907AE | 7.5 | 33 | 85 |
| 1.4 16V | 4 | 16V | AUB                | 74/101 | 02/00→10/02 | BAE907AE | 7.5 | 33 | 85 |
| 1.6     | 4 | 8V  | AKL, APF, AEH, AUR | 74/101 | 06/99→10/02 | BAE907AE | 7.5 | 33 | 85 |
| 1.6     | 4 | 8V  | ALM                | 55/75  | 06/99→10/02 | BAE851AE | 6.5 | 28 | 85 |

## CORDOBA (6K2/C2)

|           |   |     |               |         |             |          |     |    |    |
|-----------|---|-----|---------------|---------|-------------|----------|-----|----|----|
| 1.0 i     | 4 | 8V  | AER           | 37/50   | 09/96→06/99 | BAE851AE | 6.5 | 28 | 85 |
| 1.4 i     | 4 | 8V  | ABD           | 44/60   | 06/94→06/99 | BAE851AE | 6.5 | 28 | 85 |
| 1.4 i 16V | 4 | 16V | AFH           | 74/101  | 09/96→06/99 | BAE851AE | 6.5 | 28 | 85 |
| 1.6 i     | 4 | 8V  | ABU, AEE, ALM | 55/75   | 02/93→06/99 | BAE851AE | 6.5 | 28 | 85 |
| 1.6 i     | 4 | 8V  | AFT           | 74/101  | 07/96→06/99 | BAE851AE | 6.5 | 28 | 85 |
| 1.8 i     | 4 | 8V  | ABS           | 66/90   | 02/93→06/99 | BAE851AE | 6.5 | 28 | 85 |
| 1.8 i 16V | 4 | 16V | ADL           | 95/129  | 10/93→08/96 | BAE851AE | 6.5 | 28 | 85 |
| 2.0 i     | 4 | 8V  | 2E            | 85/115  | 02/93→06/99 | BAE851AE | 6.5 | 28 | 85 |
| 2.0 i 16V | 4 | 16V | ABF           | 110/149 | 08/96→06/99 | BAE851AE | 6.5 | 28 | 85 |

## CORDOBA (6L2)

|         |   |     |          |        |        |          |      |    |    |
|---------|---|-----|----------|--------|--------|----------|------|----|----|
| 1.2     | 3 | 12V | AZQ      | 47/64  | 10/02→ | BAE408AE | 15.0 | 30 | 52 |
| 1.2 12V | 3 | 12V | BXV      | 51/69  | 05/06→ | BAE408AE | 15.0 | 30 | 52 |
| 1.4 16V | 4 | 16V | BBY      | 55/75  | 09/02→ | BAE408AE | 15.0 | 30 | 52 |
| 1.4 16V | 4 | 16V | BBZ      | 74/101 | 10/02→ | BAE408AE | 15.0 | 30 | 52 |
| 1.4 16V | 4 | 16V | BXW      | 63/86  | 05/06→ | BAE408AE | 15.0 | 30 | 52 |
| 1.6     | 4 | 8V  | BAH      | 74/101 | 04/03→ | BAE907AE | 7.5  | 33 | 85 |
| 1.6 16V | 4 | 16V | BTS      | 77/105 | 11/06→ | BAE408AE | 15.0 | 30 | 52 |
| 2.0     | 4 |     | AZL, BBX | 85/115 | 09/02→ | BAE907AE | 7.5  | 33 | 85 |

## CORDOBA Vario (6K5)

|         |   |     |                    |        |             |          |     |    |    |
|---------|---|-----|--------------------|--------|-------------|----------|-----|----|----|
| 1.4     | 4 | 8V  | AKK, ANW, AUD      | 44/60  | 06/99→      | BAE907AE | 7.5 | 33 | 85 |
| 1.4 16V | 4 | 16V | APE                | 55/75  | 06/99→      | BAE907AE | 7.5 | 33 | 85 |
| 1.4 i   | 4 | 8V  | AEX, AKV, ANX, APQ | 44/60  | 09/96→06/99 | BAE851AE | 6.5 | 28 | 85 |
| 1.6     | 4 | 8V  | AKL, APF, AEH, AUR | 74/101 | 06/99→      | BAE907AE | 7.5 | 33 | 85 |
| 1.6     | 4 | 8V  | ALM                | 55/75  | 06/99→      | BAE851AE | 6.5 | 28 | 85 |
| 1.6 i   | 4 | 8V  | AEE, ALM           | 55/75  | 09/96→06/99 | BAE851AE | 6.5 | 28 | 85 |
| 1.6 i   | 4 | 8V  | AFT                | 74/101 | 09/96→06/99 | BAE851AE | 6.5 | 28 | 85 |

## IBIZA Mk II (6K1)

|           |   |     |                    |         |             |          |     |    |    |
|-----------|---|-----|--------------------|---------|-------------|----------|-----|----|----|
| 1.0       | 4 | 8V  | AAU                | 33/45   | 03/93→09/96 | BAE851AE | 6.5 | 28 | 85 |
| 1.0 i     | 4 | 8V  | AER                | 37/50   | 09/96→08/99 | BAE851AE | 6.5 | 28 | 85 |
| 1.3 i     | 4 | 8V  | AAV                | 40/54   | 03/93→08/99 | BAE851AE | 6.5 | 28 | 85 |
| 1.4 i     | 4 | 8V  | ABD, AEX, AKV, APQ | 44/60   | 09/93→08/99 | BAE851AE | 6.5 | 28 | 85 |
| 1.4 i 16V | 4 | 16V | AFH                | 74/101  | 09/96→08/99 | BAE851AE | 6.5 | 28 | 85 |
| 1.6 i     | 4 | 8V  | 1F                 | 55/75   | 09/94→06/99 | BAE851AE | 6.5 | 28 | 85 |
| 1.6 i     | 4 | 8V  | ABU, AEE, ALM      | 55/75   | 03/93→08/99 | BAE851AE | 6.5 | 28 | 85 |
| 1.6 i     | 4 | 8V  | AFT                | 74/101  | 04/96→08/99 | BAE851AE | 6.5 | 28 | 85 |
| 1.8 i 16V | 4 | 16V | ADL                | 95/129  | 11/93→08/96 | BAE851AE | 6.5 | 28 | 85 |
| 2.0 i 16V | 4 | 16V | ABF                | 110/149 | 08/96→08/99 | BAE851AE | 6.5 | 28 | 85 |

## IBIZA Mk III (6K1)

|         |   |     |                    |        |             |          |     |    |    |
|---------|---|-----|--------------------|--------|-------------|----------|-----|----|----|
| 1.0     | 4 | 8V  | ALD, ANV, AUC      | 37/50  | 08/99→02/02 | BAE907AE | 7.5 | 33 | 85 |
| 1.4     | 4 | 8V  | AKK, ANW, AUD      | 44/60  | 08/99→02/02 | BAE907AE | 7.5 | 33 | 85 |
| 1.4 16V | 4 | 16V | APE, AUA           | 55/75  | 05/00→02/02 | BAE907AE | 7.5 | 33 | 85 |
| 1.4 16V | 4 | 16V | AUB                | 74/101 | 08/99→02/02 | BAE907AE | 7.5 | 33 | 85 |
| 1.6     | 4 | 8V  | AEH, AKL, APF, AUR | 74/101 | 08/99→02/02 | BAE907AE | 7.5 | 33 | 85 |
| 1.6     | 4 | 8V  | ALM                | 55/75  | 08/99→02/02 | BAE851AE | 6.5 | 28 | 85 |

## IBIZA Mk IV (6L1)

|         |   |     |     |        |        |          |      |    |    |
|---------|---|-----|-----|--------|--------|----------|------|----|----|
| 1.2     | 3 | 12V | AZQ | 47/64  | 02/02→ | BAE408AE | 15.0 | 30 | 52 |
| 1.2 12V | 3 | 12V | BXV | 51/69  | 05/06→ | BAE408AE | 15.0 | 30 | 52 |
| 1.4 16V | 4 | 16V | AUB | 74/101 | 02/02→ | BAE907AE | 7.5  | 33 | 85 |
| 1.4 16V | 4 | 16V | BBY | 55/75  | 02/02→ | BAE408AE | 15.0 | 30 | 52 |

SEAT



kW / BHP



Amp

Out  
kVOut  
mJ

## ... SEAT



## ... IBIZA Mk IV (6L1)

|         |   |     |     |        |        |          |      |    |    |
|---------|---|-----|-----|--------|--------|----------|------|----|----|
| 1.4 16V | 4 | 16V | BBZ | 74/101 | 02/02→ | BAE408AE | 15.0 | 30 | 52 |
| 1.6     | 4 |     | BAH | 74/101 | 02/03→ | BAE907AE | 7.5  | 33 | 85 |
| 1.6 16V | 4 | 16V | BTS | 77/105 | 11/06→ | BAE408AE | 15.0 | 30 | 52 |

## LEON (1M1)

|         |   |     |               |        |        |          |      |    |    |
|---------|---|-----|---------------|--------|--------|----------|------|----|----|
| 1.4 16V | 4 | 16V | APE, AHW, AXP | 55/75  | 11/99→ | BAE907AE | 7.5  | 33 | 85 |
| 1.4 16V | 4 | 16V | BCA           | 55/75  | 11/99→ | BAE408AE | 15.0 | 30 | 52 |
| 1.6     | 4 | 8V  | AEH, AKL      | 74/101 | 11/99→ | BAE907AE | 7.5  | 33 | 85 |
| 1.6 16V | 4 | 16V | AUS           | 77/105 | 09/00→ | BAE907AE | 7.5  | 33 | 85 |
| 1.6 16V | 4 | 16V | AZD, BCB      | 77/105 | 09/00→ | BAE408AE | 15.0 | 30 | 52 |
| 1.8 20V | 4 | 20V | AGN, APG      | 92/125 | 11/99→ | BAE907AE | 7.5  | 33 | 85 |

## MARBELLA (28)

|         |   |    |        |       |             |          |     |    |    |
|---------|---|----|--------|-------|-------------|----------|-----|----|----|
| 0.9 CAT | 4 | 8V | 08 NCB | 30/41 | 11/96→10/98 | BAE801EK | 6.0 | 26 | 42 |
| 0.9 CAT | 4 | 8V | 09 NCB | 29/39 | 01/90→11/96 | BAE801EK | 6.0 | 26 | 42 |

## TOLEDO (1L)

|           |   |     |             |           |             |          |     |    |    |
|-----------|---|-----|-------------|-----------|-------------|----------|-----|----|----|
| 1.6 i     | 4 | 8V  | 1F          | ✓ 52/71   | 05/91→12/93 | BAE851AE | 6.5 | 28 | 85 |
| 1.6 i     | 4 | 8V  | 1F          | ✓ 55/75   | 01/93→03/99 | BAE851AE | 6.5 | 28 | 85 |
| 1.6 i     | 4 | 8V  | 1F, ABN, EZ | ✓ 54/73   | 05/91→03/99 | BAE851AE | 6.5 | 28 | 85 |
| 1.8 i     | 4 | 8V  | ABS, ADZ    | ✓ 66/90   | 11/93→12/96 | BAE851AE | 6.5 | 28 | 85 |
| 2.0 i     | 4 | 8V  | 2E, AGG     | ✓ 85/115  | 05/91→03/99 | BAE851AE | 6.5 | 28 | 85 |
| 2.0 i 16V | 4 | 16V | ABF         | ✓ 110/149 | 11/93→03/99 | BAE851AE | 6.5 | 28 | 85 |

## TOLEDO Mk II (1M2)

|         |   |     |          |        |             |          |      |    |    |
|---------|---|-----|----------|--------|-------------|----------|------|----|----|
| 1.4 16V | 4 | 16V | AHW      | 55/75  | 07/99→      | BAE907AE | 7.5  | 33 | 85 |
| 1.6     | 4 | 8V  | AEH, AKL | 74/101 | 04/99→09/00 | BAE907AE | 7.5  | 33 | 85 |
| 1.6 16V | 4 | 16V | AUS      | 77/105 | 09/00→      | BAE907AE | 7.5  | 33 | 85 |
| 1.6 16V | 4 | 16V | AZD      | 77/105 | 09/00→      | BAE408AE | 15.0 | 30 | 52 |
| 1.8 20V | 4 | 20V | AGN, APG | 92/125 | 04/99→      | BAE907AE | 7.5  | 33 | 85 |

## TOLEDO III (5P2)

|     |   |    |               |        |        |          |     |    |    |
|-----|---|----|---------------|--------|--------|----------|-----|----|----|
| 1.6 | 4 | 8V | BGU, BSE, BSF | 75/102 | 10/04→ | BAE907AE | 7.5 | 33 | 85 |
|-----|---|----|---------------|--------|--------|----------|-----|----|----|

## SEAT



## INCA (6K9)

|         |   |     |               |         |             |          |     |    |    |
|---------|---|-----|---------------|---------|-------------|----------|-----|----|----|
| 1.4 16V | 4 | 16V | AUA           | 55/75   | 04/00→      | BAE907AE | 7.5 | 33 | 85 |
| 1.4 i   | 4 | 8V  | AEX, AKV, APQ | ✓ 44/60 | 11/95→      | BAE851AE | 6.5 | 28 | 85 |
| 1.4 i   | 4 | 8V  | AUD           | 44/60   | 11/95→      | BAE907AE | 7.5 | 33 | 85 |
| 1.6 i   | 4 | 8V  | 1F            | ✓ 55/75 | 11/95→05/98 | BAE851AE | 6.5 | 28 | 85 |

## SKODA



## FABIA (6Y2)

|         |   |     |               |        |             |          |      |    |    |
|---------|---|-----|---------------|--------|-------------|----------|------|----|----|
| 1.0     | 4 | 8V  | AQV, ARV, ATY | 37/50  | 12/99→08/02 | BAE961AE | 7.0  | 27 | 48 |
| 1.2     | 3 |     | AZQ, BME      | 47/64  | 01/03→      | BAE408AE | 15.0 | 30 | 52 |
| 1.4     | 4 | 8V  | AME, AQW, ATZ | 50/68  | 08/99→      | BAE961AE | 7.0  | 27 | 48 |
| 1.4     | 4 | 8V  | AZF, AZE      | 44/60  | 08/00→08/02 | BAE961AE | 7.0  | 27 | 48 |
| 1.4 16V | 4 | 16V | AUA, BBY, BKY | 55/75  | 12/99→      | BAE961AE | 7.0  | 27 | 48 |
| 1.4 16V | 4 | 16V | AUB, BBZ      | 74/101 | 12/99→      | BAE907AE | 7.5  | 33 | 85 |
| 2.0     | 4 | 8V  | AQY, AZL      | 85/115 | 12/99→      | BAE907AE | 7.5  | 33 | 85 |

## FABIA Combi (6Y5)

|         |   |     |               |        |        |          |      |    |    |
|---------|---|-----|---------------|--------|--------|----------|------|----|----|
| 1.2     | 3 |     | AZQ, BME      | 47/64  | 01/03→ | BAE408AE | 15.0 | 30 | 52 |
| 1.4     | 4 | 8V  | AME, ATZ, AQW | 50/68  | 04/00→ | BAE961AE | 7.0  | 27 | 48 |
| 1.4     | 4 | 8V  | AZF, AZE      | 44/60  | 04/00→ | BAE961AE | 7.0  | 27 | 48 |
| 1.4 16V | 4 | 16V | AUA, BBY, BKY | 55/75  | 05/00→ | BAE408AE | 15.0 | 30 | 52 |
| 1.4 16V | 4 | 16V | AUA, BBY, BKY | 55/75  | 05/00→ | BAE907AE | 7.5  | 33 | 85 |
| 1.4 16V | 4 | 16V | AUA, BBY, BKY | 55/75  | 05/00→ | BAE961AE | 7.0  | 27 | 48 |
| 1.4 16V | 4 | 16V | AUB, BBZ      | 74/101 | 04/00→ | BAE408AE | 15.0 | 30 | 52 |
| 1.4 16V | 4 | 16V | AUB, BBZ      | 74/101 | 04/00→ | BAE907AE | 7.5  | 33 | 85 |
| 1.4 16V | 4 | 16V | AUB, BBZ      | 74/101 | 04/00→ | BAE961AE | 7.0  | 27 | 48 |
| 2.0     | 4 | 8V  | AZL           | 85/115 | 04/00→ | BAE907AE | 7.5  | 33 | 85 |

## FABIA Praktik

|     |   |  |          |       |        |          |      |    |    |
|-----|---|--|----------|-------|--------|----------|------|----|----|
| 1.2 | 3 |  | AZQ, BME | 47/64 | 01/03→ | BAE408AE | 15.0 | 30 | 52 |
|-----|---|--|----------|-------|--------|----------|------|----|----|



KW / BHP



Amp

Out  
kVOut  
mJ

## ... SKODA

**FABIA Saloon (6Y3)**

|         |   |                   |  |        |             |          |      |    |    |
|---------|---|-------------------|--|--------|-------------|----------|------|----|----|
| 1.2     | 3 | AZQ, BME          |  | 47/64  | 01/03→      | BAE408AE | 15.0 | 30 | 52 |
| 1.4     | 4 | 8V AME, AQW       |  | 50/68  | 07/01→      | BAE961AE | 7.0  | 27 | 48 |
| 1.4     | 4 | 8V AZF, AZE       |  | 44/60  | 04/00→08/02 | BAE961AE | 7.0  | 27 | 48 |
| 1.4 16V | 4 | 16V AUA, BBY, BKY |  | 55/75  | 10/99→      | BAE408AE | 15.0 | 30 | 52 |
| 1.4 16V | 4 | 16V AUA, BBY, BKY |  | 55/75  | 10/99→      | BAE907AE | 7.5  | 33 | 85 |
| 1.4 16V | 4 | 16V AUA, BBY, BKY |  | 55/75  | 10/99→      | BAE961AE | 7.0  | 27 | 48 |
| 1.4 16V | 4 | 16V AUB, BBZ      |  | 74/101 | 12/99→      | BAE408AE | 15.0 | 30 | 52 |
| 1.4 16V | 4 | 16V AUB, BBZ      |  | 74/101 | 12/99→      | BAE907AE | 7.5  | 33 | 85 |
| 1.4 16V | 4 | 16V AUB, BBZ      |  | 74/101 | 12/99→      | BAE961AE | 7.0  | 27 | 48 |
| 2.0     | 4 | 8V AZL            |  | 85/115 | 12/99→      | BAE907AE | 7.5  | 33 | 85 |

**FAVORIT (781)**

|                        |   |             |   |       |             |          |     |    |    |
|------------------------|---|-------------|---|-------|-------------|----------|-----|----|----|
| 1.3 (781)              | 4 | 8V 136B     | ✓ | 50/68 | 01/94→09/94 | BAE851AE | 6.5 | 28 | 85 |
| 1.3 135 (781)          | 4 | 8V 781.135  | ✓ | 42/57 | 12/91→09/94 | BAE851AE | 6.5 | 28 | 85 |
| 1.3 135 (781)          | 4 | 8V 781.135  | ✓ | 43/58 | 12/91→09/94 | BAE851AE | 6.5 | 28 | 85 |
| 1.3 135 (781)          | 4 | 8V 781.135  | ✓ | 44/60 | 10/90→09/94 | BAE851AE | 6.5 | 28 | 85 |
| 1.3 135 X,LX,GLX (781) | 4 | 8V 781.135E | ✓ | 40/54 | 01/90→09/94 | BAE851AE | 6.5 | 28 | 85 |
| 1.3 135L (781)         | 4 | 8V 781.135  | ✓ | 43/58 | 05/89→09/94 | BAE851AE | 6.5 | 28 | 85 |

**FAVORIT Forman (785)**

|             |   |             |   |       |             |          |     |    |    |
|-------------|---|-------------|---|-------|-------------|----------|-----|----|----|
| 1.3         | 4 | 8V 136B     | ✓ | 50/68 | 01/94→06/95 | BAE851AE | 6.5 | 28 | 85 |
| 1.3 (135 E) | 4 | 8V 781.135E | ✓ | 40/54 | 09/91→06/95 | BAE851AE | 6.5 | 28 | 85 |

**FELICIA (6U1)**

|        |   |               |   |       |             |          |     |    |    |
|--------|---|---------------|---|-------|-------------|----------|-----|----|----|
| 1.3    | 4 | 8V 135B, AMG  | ✓ | 40/54 | 10/94→03/98 | BAE851AE | 6.5 | 28 | 85 |
| 1.3    | 4 | 8V 135 L, AMJ | ✓ | 43/58 | 10/94→03/98 | BAE851AE | 6.5 | 28 | 85 |
| 1.3    | 4 | 8V 136B, AMH  | ✓ | 50/68 | 10/94→03/98 | BAE851AE | 6.5 | 28 | 85 |
| 1.6 LX | 4 | 8V AEE        | ✓ | 55/75 | 08/95→03/98 | BAE851AE | 6.5 | 28 | 85 |

**FELICIA Station wagon (6U5)**

|         |   |               |   |       |             |          |     |    |    |
|---------|---|---------------|---|-------|-------------|----------|-----|----|----|
| 1.3     | 4 | 8V 135 L, AMJ | ✓ | 43/58 | 08/95→03/98 | BAE851AE | 6.5 | 28 | 85 |
| 1.3 LX  | 4 | 8V 135B, AMG  | ✓ | 40/54 | 08/95→03/98 | BAE851AE | 6.5 | 28 | 85 |
| 1.3 LXI | 4 | 8V 136B, AMH  | ✓ | 50/68 | 08/95→03/98 | BAE851AE | 6.5 | 28 | 85 |
| 1.6 GLX | 4 | 8V AEE        | ✓ | 55/75 | 08/95→03/98 | BAE851AE | 6.5 | 28 | 85 |

**FELICIA II (6U1)**

|     |   |        |   |       |             |          |     |    |    |
|-----|---|--------|---|-------|-------------|----------|-----|----|----|
| 1.3 | 4 | 8V AMG |   | 40/54 | 01/98→06/01 | BAE960AE | 7.0 | 27 | 48 |
| 1.3 | 4 | 8V AMJ | ✓ | 43/58 | 01/98→06/01 | BAE851AE | 6.5 | 28 | 85 |
| 1.3 | 4 | 8V AMH |   | 50/68 | 01/98→06/01 | BAE960AE | 7.0 | 27 | 48 |
| 1.6 | 4 | 8V AEE | ✓ | 55/75 | 01/98→06/01 | BAE851AE | 6.5 | 28 | 85 |

**FELICIA Mk II Station wagon (6U5)**

|     |   |        |   |       |             |          |     |    |    |
|-----|---|--------|---|-------|-------------|----------|-----|----|----|
| 1.3 | 4 | 8V AMH |   | 50/68 | 01/98→06/01 | BAE960AE | 7.0 | 27 | 48 |
| 1.6 | 4 | 8V AEE | ✓ | 55/75 | 01/98→06/01 | BAE851AE | 6.5 | 28 | 85 |

**OCTAVIA (1U2)**

|         |   |                       |   |        |             |          |      |    |    |
|---------|---|-----------------------|---|--------|-------------|----------|------|----|----|
| 1.4     | 4 | 8V AMD                |   | 44/60  | 04/99→      | BAE961AE | 7.0  | 27 | 48 |
| 1.4 16V | 4 | 16V AXP, BCA          |   | 55/75  | 09/00→      | BAE408AE | 15.0 | 30 | 52 |
| 1.4 16V | 4 | 16V AXP, BCA          |   | 55/75  | 09/00→      | BAE907AE | 7.5  | 33 | 85 |
| 1.4 16V | 4 | 16V AXP, BCA          |   | 55/75  | 09/00→      | BAE961AE | 7.0  | 27 | 48 |
| 1.6     | 4 | 8V AEE                | ✓ | 55/75  | 09/96→09/00 | BAE851AE | 6.5  | 28 | 85 |
| 1.6     | 4 | 8V AEH, AKL           |   | 74/101 | 02/97→      | BAE907AE | 7.5  | 33 | 85 |
| 1.6     | 4 | 8V AVU, BFQ           |   | 75/102 | 11/00→      | BAE907AE | 7.5  | 33 | 85 |
| 1.8     | 4 | 20V AGN               |   | 92/125 | 09/96→      | BAE907AE | 7.5  | 33 | 85 |
| 2.0     | 4 | 8V AEG, APK, AQY, AZH |   | 85/115 | 04/99→      | BAE907AE | 7.5  | 33 | 85 |

**OCTAVIA (1Z3)**

|         |   |         |  |        |        |          |      |    |    |
|---------|---|---------|--|--------|--------|----------|------|----|----|
| 1.4     | 4 | 16V BCA |  | 55/75  | 06/04→ | BAE961AE | 7.0  | 27 | 48 |
| 1.6     | 4 | 8V BGU  |  | 75/102 | 06/04→ | BAE907AE | 7.5  | 33 | 85 |
| 1.6 FSI | 4 | BLF     |  | 85/115 | 06/04→ | BAE408AE | 15.0 | 30 | 52 |

**OCTAVIA Combi (1U5)**

|         |   |                       |   |        |        |          |      |    |    |
|---------|---|-----------------------|---|--------|--------|----------|------|----|----|
| 1.4 16V | 4 | 16V AXP, BCA          |   | 55/75  | 08/00→ | BAE408AE | 15.0 | 30 | 52 |
| 1.4 16V | 4 | 16V AXP, BCA          |   | 55/75  | 08/00→ | BAE907AE | 7.5  | 33 | 85 |
| 1.4 16V | 4 | 16V AXP, BCA          |   | 55/75  | 08/00→ | BAE961AE | 7.0  | 27 | 48 |
| 1.6     | 4 | 8V AEE                | ✓ | 55/75  | 07/98→ | BAE851AE | 6.5  | 28 | 85 |
| 1.6     | 4 | 8V AEH, AKL           |   | 74/101 | 07/98→ | BAE907AE | 7.5  | 33 | 85 |
| 1.6     | 4 | 8V AVU, BFQ           |   | 75/102 | 09/00→ | BAE907AE | 7.5  | 33 | 85 |
| 1.8 20V | 4 | 20V AGN               |   | 92/125 | 07/98→ | BAE907AE | 7.5  | 33 | 85 |
| 2.0     | 4 | 8V AEG, APK, AQY, AZH |   | 85/115 | 04/99→ | BAE907AE | 7.5  | 33 | 85 |

SKODA



kW / BHP



Amp

Out  
kVOut  
mJ
**... SKODA**

**... OCTAVIA Combi (1U5)**

|         |   |    |               |  |        |        |          |     |    |    |
|---------|---|----|---------------|--|--------|--------|----------|-----|----|----|
| 2.0     | 4 | 8V | ATF           |  | 88/120 | 01/00→ | BAE907AE | 7.5 | 33 | 85 |
| 2.0 4x4 | 4 | 8V | AQY, AZH, AEG |  | 85/115 | 05/01→ | BAE907AE | 7.5 | 33 | 85 |

**OCTAVIA Combi (1Z5)**

|         |   |  |     |  |        |        |          |      |    |    |
|---------|---|--|-----|--|--------|--------|----------|------|----|----|
| 1.6     | 4 |  | BGU |  | 75/102 | 06/04→ | BAE907AE | 7.5  | 33 | 85 |
| 1.6 FSI | 4 |  | BLF |  | 85/115 | 06/04→ | BAE408AE | 15.0 | 30 | 52 |

**ROOMSTER**

|     |   |  |  |  |        |        |          |      |    |    |
|-----|---|--|--|--|--------|--------|----------|------|----|----|
| 1.2 | 3 |  |  |  | 47/64  | 09/06→ | BAE408AE | 15.0 | 30 | 52 |
| 1.4 | 4 |  |  |  | 62/84  | 09/06→ | BAE408AE | 15.0 | 30 | 52 |
| 1.6 | 4 |  |  |  | 77/105 | 09/06→ | BAE408AE | 15.0 | 30 | 52 |

**SUPERB (3U4)**

|     |   |    |     |  |        |        |          |     |    |    |
|-----|---|----|-----|--|--------|--------|----------|-----|----|----|
| 2.0 | 4 | 8V | AZM |  | 85/115 | 02/02→ | BAE907AE | 7.5 | 33 | 85 |
|-----|---|----|-----|--|--------|--------|----------|-----|----|----|

**SKODA**

**FAVORIT Pickup (787)**

|     |   |    |         |   |       |             |          |     |    |    |
|-----|---|----|---------|---|-------|-------------|----------|-----|----|----|
| 1.3 | 4 | 8V | 135B    | ✓ | 40/54 | 12/92→06/97 | BAE851AE | 6.5 | 28 | 85 |
| 1.3 | 4 | 8V | 136B    | ✓ | 50/68 | 12/92→06/97 | BAE851AE | 6.5 | 28 | 85 |
| 1.3 | 4 | 8V | 781.135 | ✓ | 42/57 | 12/92→06/97 | BAE851AE | 6.5 | 28 | 85 |

**FELICIA I Fun (797)**

|     |   |    |            |   |       |        |          |     |    |    |
|-----|---|----|------------|---|-------|--------|----------|-----|----|----|
| 1.3 | 4 | 8V | 135B, 135M | ✓ | 40/54 | 06/97→ | BAE851AE | 6.5 | 28 | 85 |
| 1.3 | 4 | 8V | 136B, 136M | ✓ | 50/68 | 06/97→ | BAE851AE | 6.5 | 28 | 85 |

**FELICIA Pickup (797)**

|     |   |    |     |   |       |        |          |     |    |    |
|-----|---|----|-----|---|-------|--------|----------|-----|----|----|
| 1.6 | 4 | 8V | AEE | ✓ | 55/75 | 06/97→ | BAE851AE | 6.5 | 28 | 85 |
|-----|---|----|-----|---|-------|--------|----------|-----|----|----|

**VAUXHALL**

**ASTRA Mk IV**

|         |   |     |                   |  |        |        |         |     |    |    |
|---------|---|-----|-------------------|--|--------|--------|---------|-----|----|----|
| 1.4 16V | 4 | 16V | X 14 XE, Z 14 XE  |  | 66/90  | 09/98→ | BAE965A | 7.5 | 23 | 28 |
| 1.6 16V | 4 | 16V | X 16 XEL, Z 16 XE |  | 74/101 | 09/98→ | BAE965A | 7.5 | 23 | 28 |

**ASTRA MK IV Convertible**

|         |   |     |         |  |        |        |         |     |    |    |
|---------|---|-----|---------|--|--------|--------|---------|-----|----|----|
| 1.6 16V | 4 | 16V | Z 16 XE |  | 74/101 | 03/01→ | BAE965A | 7.5 | 23 | 28 |
|---------|---|-----|---------|--|--------|--------|---------|-----|----|----|

**ASTRA Mk IV Hatchback**

|         |   |     |                   |  |        |        |         |     |    |    |
|---------|---|-----|-------------------|--|--------|--------|---------|-----|----|----|
| 1.4 16V | 4 | 16V | X 14 XE, Z 14 XE  |  | 66/90  | 02/98→ | BAE965A | 7.5 | 23 | 28 |
| 1.6 16V | 4 | 16V | X 16 XEL, Z 16 XE |  | 74/101 | 02/98→ | BAE965A | 7.5 | 23 | 28 |

**ASTRA Mk IV Station wagon**

|         |   |     |                   |  |        |        |         |     |    |    |
|---------|---|-----|-------------------|--|--------|--------|---------|-----|----|----|
| 1.4 16V | 4 | 16V | X 14 XE, Z 14 XE  |  | 66/90  | 02/98→ | BAE965A | 7.5 | 23 | 28 |
| 1.6 16V | 4 | 16V | X 16 XEL, Z 16 XE |  | 74/101 | 02/98→ | BAE965A | 7.5 | 23 | 28 |

**CORSA Mk II**

|         |   |     |         |  |       |        |         |     |    |    |
|---------|---|-----|---------|--|-------|--------|---------|-----|----|----|
| 1.4 16V | 4 | 16V | Z 14 XE |  | 66/90 | 09/00→ | BAE965A | 7.5 | 23 | 28 |
|---------|---|-----|---------|--|-------|--------|---------|-----|----|----|

**MERIVA**

|         |   |     |         |  |        |        |         |     |    |    |
|---------|---|-----|---------|--|--------|--------|---------|-----|----|----|
| 1.6 16V | 4 | 16V | Z 16 XE |  | 74/100 | 05/03→ | BAE965A | 7.5 | 23 | 28 |
|---------|---|-----|---------|--|--------|--------|---------|-----|----|----|

**VECTRA**

|           |   |     |                            |  |        |        |         |     |    |    |
|-----------|---|-----|----------------------------|--|--------|--------|---------|-----|----|----|
| 1.6 i 16V | 4 | 16V | X 16 XEL, Y 16 XE, Z 16 XE |  | 74/101 | 10/95→ | BAE965A | 7.5 | 23 | 28 |
|-----------|---|-----|----------------------------|--|--------|--------|---------|-----|----|----|

**VECTRA Hatchback**

|           |   |     |                            |  |        |        |         |     |    |    |
|-----------|---|-----|----------------------------|--|--------|--------|---------|-----|----|----|
| 1.6 i 16V | 4 | 16V | X 16 XEL, Y 16 XE, Z 16 XE |  | 74/101 | 10/95→ | BAE965A | 7.5 | 23 | 28 |
|-----------|---|-----|----------------------------|--|--------|--------|---------|-----|----|----|

**VECTRA Station wagon**

|           |   |     |                            |  |        |        |         |     |    |    |
|-----------|---|-----|----------------------------|--|--------|--------|---------|-----|----|----|
| 1.6 i 16V | 4 | 16V | X 16 XEL, Y 16 XE, Z 16 XE |  | 74/101 | 11/96→ | BAE965A | 7.5 | 23 | 28 |
|-----------|---|-----|----------------------------|--|--------|--------|---------|-----|----|----|

**VECTRA Mk II**

|           |   |     |         |  |        |        |         |     |    |    |
|-----------|---|-----|---------|--|--------|--------|---------|-----|----|----|
| 1.6 i 16V | 4 | 16V | Z 16 XE |  | 74/100 | 06/04→ | BAE965A | 7.5 | 23 | 28 |
|-----------|---|-----|---------|--|--------|--------|---------|-----|----|----|

**VECTRA Mk II Estate**

|           |   |     |         |  |        |        |         |     |    |    |
|-----------|---|-----|---------|--|--------|--------|---------|-----|----|----|
| 1.6 i 16V | 4 | 16V | Z 16 XE |  | 74/100 | 06/04→ | BAE965A | 7.5 | 23 | 28 |
|-----------|---|-----|---------|--|--------|--------|---------|-----|----|----|





**VECTRA Mk II GTS**

|           |   |     |         |  |        |        |         |     |    |    |
|-----------|---|-----|---------|--|--------|--------|---------|-----|----|----|
| 1.6 i 16V | 4 | 16V | Z 16 XE |  | 74/100 | 06/04→ | BAE965A | 7.5 | 23 | 28 |
|-----------|---|-----|---------|--|--------|--------|---------|-----|----|----|

**ZAFIRA**

|         |   |     |          |  |        |        |         |     |    |    |
|---------|---|-----|----------|--|--------|--------|---------|-----|----|----|
| 1.6 16V | 4 | 16V | X 16 XEL |  | 74/101 | 04/99→ | BAE965A | 7.5 | 23 | 28 |
|---------|---|-----|----------|--|--------|--------|---------|-----|----|----|



|   |   |  |  |  |  |  | kw / BHP |  |  | Amp  | Out kV | Out mJ |
|---|---|---|---|---|---|---|----------|---|---|------|--------|--------|
| <b>VAUXHALL</b>    |   |   |   |   |   |   |          |   |   |      |        |        |
| <b>VIVARO Box</b>   |   |   |   |   |   |   |          |   |   |      |        |        |
| 2.0 16V   | 4 | 16V   | F4R 720 >ENG.C002324  |   |   |   | 88/120   | 08/01 →   | BAE409A   | 7.5  | 26     | 37     |
| <b>VIVARO Combi</b>   |   |   |   |   |   |   |          |   |   |      |        |        |
| 2.0 16V   | 4 | 16V   | F4R 720 >ENG.C002324  |   |   |   | 88/120   | 08/01 →   | BAE409A   | 7.5  | 26     | 37     |
| <b>VOLKSWAGEN</b>  |   |   |   |   |   |   |          |   |   |      |        |        |
| <b>BORA (1J2)</b>   |   |   |   |   |   |   |          |   |   |      |        |        |
| 1.4 16V   | 4 | 16V   | AHW, AKQ, APE, AXP, BCA   |   |   |   | 55/75    | 03/00 →   | BAE907AE  | 7.5  | 33     | 85     |
| 1.6   | 4 | 8V  | AEH, AKL, APF   |   |   |   | 74/101   | 10/98 →   | BAE907AE  | 7.5  | 33     | 85     |
| 1.6   | 4 | 8V  | AVU, BFQ  |   |   |   | 75/102   | 08/00 →   | BAE907AE  | 7.5  | 33     | 85     |
| 1.6 16V   | 4 | 16V   | ATN, AUS  |   |   |   | 77/105   | 05/00 →05/05  | BAE907AE  | 7.5  | 33     | 85     |
| 1.6 16V   | 4 | 16V   | AZD, BCB  |   |   |   | 77/105   | 05/00 →05/05  | BAE408AE  | 15.0 | 30     | 52     |
| 1.6 FSI   | 4 |   | BAD   |   |   |   | 81/110   | 01/02 →   | BAE408AE  | 15.0 | 30     | 52     |
| 1.8   | 4 | 20V   | AGN   |   |   |   | 92/125   | 10/98 →   | BAE907AE  | 7.5  | 33     | 85     |
| 1.8 4motion   | 4 | 20V   | AGN   |   |   |   | 92/125   | 02/99 →05/05  | BAE907AE  | 7.5  | 33     | 85     |
| 2.0   | 4 | 8V  | AQY, APK, AZH   |   |   |   | 85/115   | 10/98 →   | BAE907AE  | 7.5  | 33     | 85     |
| 2.0 4motion   | 4 | 8V  | AZH   |   |   |   | 85/115   | 04/00 →05/05  | BAE907AE  | 7.5  | 33     | 85     |
| <b>BORA Station wagon (1J6)</b>   |   |   |   |   |   |   |          |   |   |      |        |        |
| 1.4 16V   | 4 | 16V   | AHW, AXP, BCA   |   |   |   | 55/75    | 09/01 →   | BAE408AE  | 15.0 | 30     | 52     |
| 1.6   | 4 | 8V  | AEH, AKL, APF   |   |   |   | 74/101   | 05/99 →05/05  | BAE907AE  | 7.5  | 33     | 85     |
| 1.6   | 4 | 8V  | AVU, BFQ  |   |   |   | 75/102   | 08/00 →05/05  | BAE907AE  | 7.5  | 33     | 85     |
| 1.6 16V   | 4 | 16V   | ATN, AUS  |   |   |   | 77/105   | 02/00 →05/05  | BAE907AE  | 7.5  | 33     | 85     |
| 1.6 16V   | 4 | 16V   | AZD, BCB  |   |   |   | 77/105   | 02/00 →05/05  | BAE408AE  | 15.0 | 30     | 52     |
| 1.6 FSI   | 4 |   | BAD   |   |   |   | 81/110   | 01/02 →   | BAE408AE  | 15.0 | 30     | 52     |
| 1.8 4motion   | 4 | 20V   | AGN   |   |   |   | 92/125   | 05/99 →05/05  | BAE907AE  | 7.5  | 33     | 85     |
| 2.0   | 4 | 8V  | APK, AQY, AZG, AZH, AZJ   |   |   |   | 85/115   | 05/99 →05/05  | BAE907AE  | 7.5  | 33     | 85     |
| 2.0 4motion   | 4 | 8V  | AZH   |   |   |   | 85/115   | 04/00 →05/05  | BAE907AE  | 7.5  | 33     | 85     |
| <b>CADDY II Station wagon (9K9B)</b>  |   |   |   |   |   |   |          |   |   |      |        |        |
| 1.4   | 4 | 8V  | AEX, AKV, APQ   | ✓   |   |   | 44/60    | 11/95 →01/04  | BAE851AE  | 6.5  | 28     | 85     |
| 1.4   | 4 | 8V  | AUD   |   |   |   | 44/60    | 11/95 →01/04  | BAE907AE  | 7.5  | 33     | 85     |
| 1.4 16V   | 4 | 16V   | AUA   |   |   |   | 55/75    | 08/00 →01/04  | BAE907AE  | 7.5  | 33     | 85     |
| 1.6   | 4 | 8V  | 1F  | ✓   |   |   | 55/75    | 11/95 →05/97  | BAE851AE  | 6.5  | 28     | 85     |
| <b>CADDY III Station wagon (2KB)</b>  |   |   |   |   |   |   |          |   |   |      |        |        |
| 1.4   | 4 |   | BCA   |   |   |   | 55/75    | 03/04 →   | BAE408AE  | 15.0 | 30     | 52     |
| <b>CORRADO (53I)</b>  |   |   |   |   |   |   |          |   |   |      |        |        |
| 2.0 i   | 4 | 8V  | 2E, ADY   | ✓   |   |   | 85/115   | 04/93 →12/95  | BAE851AE  | 6.5  | 28     | 85     |
| 2.0 i 16V   | 4 | 16V   | 9A  | ✓   |   |   | 100/136  | 08/91 →12/95  | BAE851AE  | 6.5  | 28     | 85     |
| <b>EOS</b>  |   |   |   |   |   |   |          |   |   |      |        |        |
| 1.6 FSI   | 4 |   |   |   |   |   | 85/115   | 06/06 →   | BAE408AE  | 15.0 | 30     | 52     |
| <b>FOX (5Z1)</b>  |   |   |   |   |   |   |          |   |   |      |        |        |
| 1.2   | 3 |   | BMD   |   |   |   | 40/54    | 04/05 →   | BAE408AE  | 15.0 | 30     | 52     |
| 1.4   | 4 |   | BKR   |   |   |   | 55/75    | 04/05 →   | BAE907AE  | 7.5  | 33     | 85     |
| <b>GOLF Mk II (19E, 1G1)</b>  |   |   |   |   |   |   |          |   |   |      |        |        |
| 1.3 CAT   | 4 | 8V  | NZ, 2G  | ✓   |   |   | 40/54    | 06/86 →12/92  | BAE851AE  | 6.5  | 28     | 85     |
| <b>GOLF Mk III (1H1)</b>  |   |   |   |   |   |   |          |   |   |      |        |        |
| 1.4   | 4 | 8V  | ABD, AEX  | ✓   |   |   | 40/54    | 11/91 →08/97  | BAE851AE  | 6.5  | 28     | 85     |
| 1.4   | 4 | 8V  | ABD, AEX  | ✓   |   |   | 44/60    | 10/91 →08/97  | BAE851AE  | 6.5  | 28     | 85     |
| 1.6   | 4 | 8V  | ABU, AEA, AEE   | ✓   |   |   | 55/75    | 09/92 →08/97  | BAE851AE  | 6.5  | 28     | 85     |
| 1.6   | 4 | 8V  | AFT, AEK  | ✓   |   |   | 74/101   | 07/95 →08/97  | BAE851AE  | 6.5  | 28     | 85     |
| 1.8   | 4 | 8V  | AAM   | ✓   |   |   | 55/75    | 11/91 →08/97  | BAE851AE  | 6.5  | 28     | 85     |
| 1.8   | 4 | 8V  | ABS, ADZ  | ✓   |   |   | 66/90    | 11/91 →08/97  | BAE851AE  | 6.5  | 28     | 85     |
| 1.8 Syncro (1HX1)   | 4 | 8V  | ABS, ADZ  | ✓   |   |   | 66/90    | 01/93 →08/97  | BAE851AE  | 6.5  | 28     | 85     |
| 2.0   | 4 | 8V  | 2E, ADY, AGG, AKR   | ✓   |   |   | 85/115   | 11/91 →08/97  | BAE851AE  | 6.5  | 28     | 85     |
| 2.0 GTI 16V   | 4 | 16V   | ABF   | ✓   |   |   | 110/149  | 08/92 →08/97  | BAE851AE  | 6.5  | 28     | 85     |
| 2.0 Syncro (1HX1)   | 4 | 8V  | AGG   | ✓   |   |   | 85/115   | 08/95 →08/97  | BAE851AE  | 6.5  | 28     | 85     |
| <b>GOLF Mk III Convertible (1E7)</b>  |   |   |   |   |   |   |          |   |   |      |        |        |
| 1.6   | 4 | 8V  | AFT, AKS  | ✓   |   |   | 74/101   | 10/94 →05/98  | BAE851AE  | 6.5  | 28     | 85     |
| 1.6   | 4 | 8V  | AFT, AKS  | ✓   |   |   | 74/101   | 06/98 →   | BAE851AE  | 6.5  | 28     | 85     |
| 1.8   | 4 | 8V  | AAM   | ✓   |   |   | 55/75    | 07/93 →05/98  | BAE851AE  | 6.5  | 28     | 85     |
| 1.8   | 4 | 8V  | AAM, ANN  | ✓   |   |   | 55/75    | 06/98 →   | BAE851AE  | 6.5  | 28     | 85     |
| 1.8   | 4 | 8V  | ABS, ADZ  | ✓   |   |   | 66/90    | 07/93 →05/98  | BAE851AE  | 6.5  | 28     | 85     |

VOLKSWAGEN



kW / BHP



Amp

Out  
kVOut  
mJ

### ... VOLKSWAGEN

#### ... GOLF Mk III Convertible (1E7)

|     |   |    |                   |   |        |             |          |     |    |    |
|-----|---|----|-------------------|---|--------|-------------|----------|-----|----|----|
| 1.8 | 4 | 8V | ADZ, ANP          | ✓ | 66/90  | 06/98→      | BAE851AE | 6.5 | 28 | 85 |
| 2.0 | 4 | 8V | 2E, ADY, AGG, AKR | ✓ | 85/115 | 07/93→05/98 | BAE851AE | 6.5 | 28 | 85 |
| 2.0 | 4 | 8V | AGG, AKR          | ✓ | 85/115 | 06/98→      | BAE851AE | 6.5 | 28 | 85 |

#### GOLF Mk III Station wagon (1H5)

|            |   |    |                   |   |        |             |          |     |    |    |
|------------|---|----|-------------------|---|--------|-------------|----------|-----|----|----|
| 1.4        | 4 |    | ABD               | ✓ | 40/54  | 07/93→04/99 | BAE851AE | 6.5 | 28 | 85 |
| 1.4        | 4 | 8V | ABD, AEX, APQ     | ✓ | 44/60  | 07/93→04/99 | BAE851AE | 6.5 | 28 | 85 |
| 1.6        | 4 | 8V | ABU, AEA, AEE     | ✓ | 55/75  | 07/93→12/97 | BAE851AE | 6.5 | 28 | 85 |
| 1.6        | 4 | 8V | AFT, AKS          | ✓ | 74/101 | 07/94→04/99 | BAE851AE | 6.5 | 28 | 85 |
| 1.8        | 4 | 8V | AAM, ANN          | ✓ | 55/75  | 07/93→04/99 | BAE851AE | 6.5 | 28 | 85 |
| 1.8        | 4 | 8V | ABS, ADZ, ANP     | ✓ | 66/90  | 07/93→04/99 | BAE851AE | 6.5 | 28 | 85 |
| 1.8 Syncro | 4 | 8V | ADZ               | ✓ | 66/90  | 10/94→04/99 | BAE851AE | 6.5 | 28 | 85 |
| 2.0        | 4 | 8V | 2E, ADY, AGG, AKR | ✓ | 85/115 | 07/93→04/99 | BAE851AE | 6.5 | 28 | 85 |

#### GOLF Mk IV (1J1)

|             |   |     |                    |  |        |             |          |      |    |    |
|-------------|---|-----|--------------------|--|--------|-------------|----------|------|----|----|
| 1.4 16V     | 4 | 16V | APE, AHW, AXP      |  | 55/75  | 08/97→06/05 | BAE907AE | 7.5  | 33 | 85 |
| 1.4 16V     | 4 | 16V | BCA                |  | 55/75  | 08/97→06/05 | BAE408AE | 15.0 | 30 | 52 |
| 1.6         | 4 | 8V  | AEH, AKL, APF      |  | 74/101 | 08/97→02/00 | BAE907AE | 7.5  | 33 | 85 |
| 1.6         | 4 | 8V  | AVU, BFQ           |  | 75/102 | 08/00→06/05 | BAE907AE | 7.5  | 33 | 85 |
| 1.6 16V     | 4 | 16V | ATN, AUS           |  | 77/105 | 02/00→      | BAE907AE | 7.5  | 33 | 85 |
| 1.6 16V     | 4 | 16V | AZD, BCB           |  | 77/105 | 02/00→      | BAE408AE | 15.0 | 30 | 52 |
| 1.6 FSI     | 4 |     | BAD                |  | 81/110 | 01/02→      | BAE408AE | 15.0 | 30 | 52 |
| 1.8         | 4 | 20V | AGN                |  | 92/125 | 08/97→06/05 | BAE907AE | 7.5  | 33 | 85 |
| 1.8 4motion | 4 | 20V | AGN                |  | 92/125 | 05/98→06/05 | BAE907AE | 7.5  | 33 | 85 |
| 2.0         | 4 | 8V  | APK, AQY, AZG, AZJ |  | 85/115 | 07/98→      | BAE907AE | 7.5  | 33 | 85 |
| 2.0 4motion | 4 | 8V  | AZH                |  | 85/115 | 10/00→06/05 | BAE907AE | 7.5  | 33 | 85 |

#### GOLF Mk IV Station wagon (1J5)

|             |   |     |               |  |        |             |          |      |    |    |
|-------------|---|-----|---------------|--|--------|-------------|----------|------|----|----|
| 1.4 16V     | 4 | 16V | APE, AHW, AXP |  | 55/75  | 05/99→      | BAE408AE | 15.0 | 30 | 52 |
| 1.4 16V     | 4 | 16V | BCA           |  | 55/75  | 05/99→      | BAE907AE | 7.5  | 33 | 85 |
| 1.6         | 4 | 8V  | AEH, AKL, APF |  | 74/101 | 05/99→02/00 | BAE907AE | 7.5  | 33 | 85 |
| 1.6         | 4 | 8V  | AVU           |  | 75/102 | 08/00→      | BAE907AE | 7.5  | 33 | 85 |
| 1.6 16V     | 4 | 16V | ATN, AUS      |  | 77/105 | 02/00→      | BAE907AE | 7.5  | 33 | 85 |
| 1.6 16V     | 4 | 16V | AZD, BCB      |  | 77/105 | 02/00→      | BAE408AE | 15.0 | 30 | 52 |
| 1.6 FSI     | 4 |     | BAD           |  | 81/110 | 01/02→      | BAE408AE | 15.0 | 30 | 52 |
| 1.8 4motion | 4 | 20V | AGN           |  | 92/125 | 05/99→      | BAE907AE | 7.5  | 33 | 85 |
| 2.0         | 4 | 8V  | APK, AQY      |  | 85/115 | 05/99→      | BAE907AE | 7.5  | 33 | 85 |
| 2.0 4motion | 4 | 8V  | AZH           |  | 85/115 | 10/00→      | BAE907AE | 7.5  | 33 | 85 |
| 2.0 Bi-Fuel | 4 |     | BEH           |  | 85/115 | 02/02→      | BAE907AE | 7.5  | 33 | 85 |

#### GOLF V (1K1)

|         |   |     |     |  |         |        |          |      |    |    |
|---------|---|-----|-----|--|---------|--------|----------|------|----|----|
| 1.4 16V | 4 | 16V | BCA |  | 55/75   | 10/03→ | BAE408AE | 15.0 | 30 | 52 |
| 1.4 16V | 4 | 16V | BUD |  | 59/80   | 05/06→ | BAE408AE | 15.0 | 30 | 52 |
| 1.4 FSI | 4 |     | BKG |  | 66/90   | 10/03→ | BAE408AE | 15.0 | 30 | 52 |
| 1.4 TSI | 4 |     | BLG |  | 125/170 | 11/05→ | BAE408AE | 15.0 | 30 | 52 |
| 1.6     | 4 |     | BGU |  | 75/102  | 01/04→ | BAE907AE | 7.5  | 33 | 85 |
| 1.6 FSI | 4 |     | BAG |  | 85/115  | 10/03→ | BAE408AE | 15.0 | 30 | 52 |

#### GOLF V PLUS (5M1)

|         |   |     |     |  |        |        |          |      |    |    |
|---------|---|-----|-----|--|--------|--------|----------|------|----|----|
| 1.4 16V | 4 | 16V | BCA |  | 55/75  | 01/05→ | BAE408AE | 15.0 | 30 | 52 |
| 1.6 FSI | 4 |     | BLF |  | 85/115 | 01/05→ | BAE408AE | 15.0 | 30 | 52 |

#### JETTA III (1K2)

|         |   |  |     |  |        |        |          |      |    |    |
|---------|---|--|-----|--|--------|--------|----------|------|----|----|
| 1.6 FSI | 4 |  | BLF |  | 85/115 | 09/05→ | BAE408AE | 15.0 | 30 | 52 |
|---------|---|--|-----|--|--------|--------|----------|------|----|----|

#### KAEFER

|                 |   |    |     |   |       |             |          |     |    |    |
|-----------------|---|----|-----|---|-------|-------------|----------|-----|----|----|
| 1600 i (Mexico) | 4 | 8V | ACD | ✓ | 34/46 | 10/92→07/03 | BAE851AE | 6.5 | 28 | 85 |
|-----------------|---|----|-----|---|-------|-------------|----------|-----|----|----|

#### LUPO (6X1, 6E1)

|         |   |     |                              |  |        |             |          |     |    |    |
|---------|---|-----|------------------------------|--|--------|-------------|----------|-----|----|----|
| 1.0     | 4 | 8V  | AER, AHT, ALD, ALL, ANV, AUC |  | 37/50  | 09/98→      | BAE961AE | 7.0 | 27 | 48 |
| 1.4     | 4 | 8V  | AUD                          |  | 44/60  | 10/00→07/05 | BAE907AE | 7.5 | 33 | 85 |
| 1.4 16V | 4 | 16V | AFK, ANM, AQQ, AUB           |  | 74/101 | 08/99→07/05 | BAE907AE | 7.5 | 33 | 85 |
| 1.4 16V | 4 | 16V | AHW, AKQ, APE, AUA, BBY      |  | 55/75  | 09/98→07/05 | BAE907AE | 7.5 | 33 | 85 |
| 1.6 GTI | 4 | 16V | AVY                          |  | 92/125 | 09/00→07/05 | BAE907AE | 7.5 | 33 | 85 |

#### MULTIVAN Mk V (7HM)

|     |   |  |     |  |        |        |          |     |    |    |
|-----|---|--|-----|--|--------|--------|----------|-----|----|----|
| 2.0 | 4 |  | AXA |  | 85/115 | 04/03→ | BAE907AE | 7.5 | 33 | 85 |
|-----|---|--|-----|--|--------|--------|----------|-----|----|----|

VOLKSWAGEN



KW / BHP



Amp

Out  
kVOut  
mJ

### ... VOLKSWAGEN

#### NEW BEETLE (9C1, 1C1)

|     |   |     |                    |  |        |             |          |      |    |    |
|-----|---|-----|--------------------|--|--------|-------------|----------|------|----|----|
| 1.4 | 4 | 16V | BCA                |  | 55/75  | 11/01→      | BAE408AE | 15.0 | 30 | 52 |
| 1.6 | 4 | 8V  | AWH                |  | 74/101 | 10/99→09/00 | BAE907AE | 7.5  | 33 | 85 |
| 1.6 | 4 | 8V  | AYD                |  | 75/102 | 09/00→      | BAE907AE | 7.5  | 33 | 85 |
| 2.0 | 4 | 8V  | AEG, APK, AQY, AZG |  | 85/115 | 01/98→      | BAE907AE | 7.5  | 33 | 85 |

#### NEW BEETLE Cabriolet (1Y7)

|     |   |     |     |  |       |        |          |      |    |    |
|-----|---|-----|-----|--|-------|--------|----------|------|----|----|
| 1.4 | 4 | 16V | BCA |  | 55/75 | 01/03→ | BAE408AE | 15.0 | 30 | 52 |
|-----|---|-----|-----|--|-------|--------|----------|------|----|----|

#### NEW BEETLE Convertible (1Y7)

|     |   |    |               |  |        |        |          |     |    |    |
|-----|---|----|---------------|--|--------|--------|----------|-----|----|----|
| 2.0 | 4 | 8V | AZJ, BDC, BGD |  | 85/115 | 01/03→ | BAE907AE | 7.5 | 33 | 85 |
|-----|---|----|---------------|--|--------|--------|----------|-----|----|----|

#### PASSAT (3A2, 351)

|         |   |     |              |   |         |             |          |     |    |    |
|---------|---|-----|--------------|---|---------|-------------|----------|-----|----|----|
| 1.6     | 4 | 8V  | AEK          | ✓ | 74/101  | 10/94→08/96 | BAE851AE | 6.5 | 28 | 85 |
| 1.8     | 4 | 8V  | AAM          | ✓ | 55/75   | 08/90→08/96 | BAE851AE | 6.5 | 28 | 85 |
| 1.8     | 4 | 8V  | ADZ          | ✓ | 66/90   | 02/88→08/96 | BAE851AE | 6.5 | 28 | 85 |
| 2.0     | 4 | 8V  | 2E, ADY, AGG | ✓ | 85/115  | 02/90→08/96 | BAE851AE | 6.5 | 28 | 85 |
| 2.0     | 4 | 8V  | AEP          | ✓ | 79/107  | 03/95→08/96 | BAE851AE | 6.5 | 28 | 85 |
| 2.8 VR6 | 6 | 12V | AAA          | ✓ | 128/174 | 06/91→08/96 | BAE851AE | 6.5 | 28 | 85 |

#### PASSAT (3A5, 351)

|            |   |    |    |   |        |             |          |     |    |    |
|------------|---|----|----|---|--------|-------------|----------|-----|----|----|
| 2.0 Syncro | 4 | 8V | 2E | ✓ | 85/115 | 10/90→08/96 | BAE851AE | 6.5 | 28 | 85 |
|------------|---|----|----|---|--------|-------------|----------|-----|----|----|

#### PASSAT (3B2)

|     |   |    |               |  |        |             |          |     |    |    |
|-----|---|----|---------------|--|--------|-------------|----------|-----|----|----|
| 1.6 | 4 | 8V | AHL, ANA, ARM |  | 74/101 | 10/96→11/00 | BAE907AE | 7.5 | 33 | 85 |
|-----|---|----|---------------|--|--------|-------------|----------|-----|----|----|

#### PASSAT (3B3)

|             |   |    |     |  |        |             |          |     |    |    |
|-------------|---|----|-----|--|--------|-------------|----------|-----|----|----|
| 1.6         | 4 | 8V | ALZ |  | 75/102 | 11/00→05/05 | BAE907AE | 7.5 | 33 | 85 |
| 2.0         | 4 | 8V | AZM |  | 85/115 | 11/00→05/05 | BAE907AE | 7.5 | 33 | 85 |
| 2.0 4motion | 4 | 8V | AZM |  | 85/115 | 11/00→05/05 | BAE907AE | 7.5 | 33 | 85 |

#### PASSAT (3C2)

|         |   |  |     |  |        |        |          |      |    |    |
|---------|---|--|-----|--|--------|--------|----------|------|----|----|
| 1.6 FSI | 4 |  | BLF |  | 85/115 | 03/05→ | BAE408AE | 15.0 | 30 | 52 |
|---------|---|--|-----|--|--------|--------|----------|------|----|----|

#### PASSAT Estate (3A2, 351)

|     |   |    |     |   |        |             |          |     |    |    |
|-----|---|----|-----|---|--------|-------------|----------|-----|----|----|
| 1.6 | 4 | 8V | AEK | ✓ | 74/101 | 07/94→12/95 | BAE851AE | 6.5 | 28 | 85 |
|-----|---|----|-----|---|--------|-------------|----------|-----|----|----|

#### PASSAT Variant (3A5, 351)

|            |   |     |              |   |         |             |          |     |    |    |
|------------|---|-----|--------------|---|---------|-------------|----------|-----|----|----|
| 1.8        | 4 | 8V  | AAM          | ✓ | 55/75   | 08/90→05/97 | BAE851AE | 6.5 | 28 | 85 |
| 1.8        | 4 | 8V  | ABS, ADZ, RP | ✓ | 66/90   | 02/88→05/97 | BAE851AE | 6.5 | 28 | 85 |
| 2.0        | 4 |     | AEP          | ✓ | 79/107  | 03/95→08/96 | BAE851AE | 6.5 | 28 | 85 |
| 2.0        | 4 | 8V  | 2E, ADY, AGG | ✓ | 85/115  | 02/90→05/97 | BAE851AE | 6.5 | 28 | 85 |
| 2.0 Syncro | 4 | 8V  | 2E           | ✓ | 85/115  | 10/90→05/97 | BAE851AE | 6.5 | 28 | 85 |
| 2.8 VR6    | 6 | 12V | AAA          | ✓ | 128/174 | 06/91→05/97 | BAE851AE | 6.5 | 28 | 85 |

#### PASSAT Variant (3B5)

|     |   |    |               |  |        |             |          |     |    |    |
|-----|---|----|---------------|--|--------|-------------|----------|-----|----|----|
| 1.6 | 4 | 8V | AHL, ANA, ARM |  | 74/101 | 06/97→11/00 | BAE907AE | 7.5 | 33 | 85 |
|-----|---|----|---------------|--|--------|-------------|----------|-----|----|----|

#### PASSAT Variant (3B6)

|             |   |    |     |  |        |             |          |     |    |    |
|-------------|---|----|-----|--|--------|-------------|----------|-----|----|----|
| 1.6         | 4 | 8V | ALZ |  | 75/102 | 11/00→05/05 | BAE907AE | 7.5 | 33 | 85 |
| 2.0         | 4 | 8V | AZM |  | 85/115 | 11/00→05/05 | BAE907AE | 7.5 | 33 | 85 |
| 2.0 4motion | 4 | 8V | AZM |  | 85/115 | 11/00→05/05 | BAE907AE | 7.5 | 33 | 85 |

#### PASSAT Variant (3C5)

|         |   |  |     |  |        |        |          |      |    |    |
|---------|---|--|-----|--|--------|--------|----------|------|----|----|
| 1.6 FSI | 4 |  | BLF |  | 85/115 | 08/05→ | BAE408AE | 15.0 | 30 | 52 |
|---------|---|--|-----|--|--------|--------|----------|------|----|----|

#### POLO (6N1)

|                 |   |     |               |   |        |             |          |     |    |    |
|-----------------|---|-----|---------------|---|--------|-------------|----------|-----|----|----|
| 45 1.0          | 4 | 8V  | AEV           | ✓ | 33/45  | 10/94→09/96 | BAE851AE | 6.5 | 28 | 85 |
| 50 1.0          | 4 | 8V  | AER, ALL      | ✓ | 37/50  | 09/96→10/99 | BAE851AE | 6.5 | 28 | 85 |
| 55 1.3          | 4 | 8V  | ADX           | ✓ | 40/54  | 10/94→07/95 | BAE851AE | 6.5 | 28 | 85 |
| 55 1.4          | 4 | 8V  | AEX           | ✓ | 40/54  | 08/95→10/99 | BAE851AE | 6.5 | 28 | 85 |
| 60 1.4          | 4 | 8V  | AEX, AKV, APQ | ✓ | 44/60  | 07/95→10/99 | BAE851AE | 6.5 | 28 | 85 |
| 75 1.6          | 4 | 8V  | AEA, AEE, AHS | ✓ | 55/75  | 10/94→10/99 | BAE851AE | 6.5 | 28 | 85 |
| 100 1.4 16V     | 4 | 16V | AFH           | ✓ | 74/101 | 04/96→10/99 | BAE851AE | 6.5 | 28 | 85 |
| 120 1.6 16V GTI | 4 | 16V | AJV           |   | 88/120 | 09/98→10/99 | BAE907AE | 7.5 | 33 | 85 |

#### POLO (6N2)

|             |   |     |          |  |        |             |          |     |    |    |
|-------------|---|-----|----------|--|--------|-------------|----------|-----|----|----|
| 1.0         | 4 | 8V  | ALD, AUC |  | 37/50  | 10/99→09/01 | BAE907AE | 7.5 | 33 | 85 |
| 1.4         | 4 |     | AKP      |  | 40/54  | 10/99→09/01 | BAE907AE | 7.5 | 33 | 85 |
| 1.4         | 4 | 8V  | AKK, AUD |  | 44/60  | 10/99→09/01 | BAE907AE | 7.5 | 33 | 85 |
| 1.4 16V     | 4 | 16V | AFK, AUB |  | 74/101 | 10/99→09/01 | BAE907AE | 7.5 | 33 | 85 |
| 1.4 16V     | 4 | 16V | AHW, AUA |  | 55/75  | 10/99→09/01 | BAE907AE | 7.5 | 33 | 85 |
| 1.6 16V GTI | 4 | 16V | ARC, AVY |  | 92/125 | 10/99→09/01 | BAE907AE | 7.5 | 33 | 85 |

VOLKSWAGEN



kW / BHP



Amp

Out  
kVOut  
mJ
**... VOLKSWAGEN**

**POLO (86C, 80)**

|         |   |    |               |   |       |             |          |     |    |    |
|---------|---|----|---------------|---|-------|-------------|----------|-----|----|----|
| 1.0     | 4 | 8V | HZ            | ✓ | 33/45 | 08/85→01/92 | BAE851AE | 6.5 | 28 | 85 |
| 1.0 CAT | 4 | 8V | AAU, AAK, ACM | ✓ | 33/45 | 08/89→09/94 | BAE851AE | 6.5 | 28 | 85 |
| 1.3 CAT | 4 | 8V | 2G, NZ, AAV   | ✓ | 40/54 | 07/87→09/94 | BAE851AE | 6.5 | 28 | 85 |
| 1.3 CAT | 4 | 8V | 3F            | ✓ | 55/75 | 10/89→03/91 | BAE851AE | 6.5 | 28 | 85 |

**POLO (9N )**

|         |   |     |          |  |        |        |          |      |    |    |
|---------|---|-----|----------|--|--------|--------|----------|------|----|----|
| 1.2     | 3 | 12V | AZQ      |  | 47/64  | 10/01→ | BAE408AE | 15.0 | 30 | 52 |
| 1.4 16V | 4 | 16V | AUA      |  | 55/75  | 10/01→ | BAE907AE | 7.5  | 33 | 85 |
| 1.4 16V | 4 | 16V | AUB, BBZ |  | 74/101 | 10/01→ | BAE408AE | 15.0 | 30 | 52 |
| 1.4 16V | 4 | 16V | BBY      |  | 55/75  | 10/01→ | BAE408AE | 15.0 | 30 | 52 |
| 1.4 FSI | 4 |     | AXU      |  | 63/86  | 05/02→ | BAE408AE | 15.0 | 30 | 52 |

**POLO CLASSIC (86C, 80)**

|         |   |    |     |   |       |             |          |     |    |    |
|---------|---|----|-----|---|-------|-------------|----------|-----|----|----|
| 1.0     | 4 | 8V | AAU | ✓ | 33/45 | 01/85→09/94 | BAE851AE | 6.5 | 28 | 85 |
| 1.3 CAT | 4 | 8V | NZ  | ✓ | 40/54 | 07/87→09/94 | BAE851AE | 6.5 | 28 | 85 |

**POLO Coupe (86C, 80)**

|         |   |    |             |   |        |             |          |     |    |    |
|---------|---|----|-------------|---|--------|-------------|----------|-----|----|----|
| 1.0     | 4 | 8V | HZ          | ✓ | 33/45  | 08/85→01/92 | BAE851AE | 6.5 | 28 | 85 |
| 1.0 CAT | 4 | 8V | AAU, ACM    | ✓ | 33/45  | 08/89→09/94 | BAE851AE | 6.5 | 28 | 85 |
| 1.3 CAT | 4 | 8V | 3F          | ✓ | 55/75  | 10/89→09/94 | BAE851AE | 6.5 | 28 | 85 |
| 1.3 CAT | 4 | 8V | NZ, 2G, AAV | ✓ | 40/54  | 07/87→08/94 | BAE851AE | 6.5 | 28 | 85 |
| 1.3 G40 | 4 |    | PY          | ✓ | 83/113 | 08/90→09/94 | BAE851AE | 6.5 | 28 | 85 |

**POLO Saloon**

|     |   |     |     |  |        |        |          |      |    |    |
|-----|---|-----|-----|--|--------|--------|----------|------|----|----|
| 1.4 | 4 | 16V | BBY |  | 55/75  | 07/03→ | BAE408AE | 15.0 | 30 | 52 |
| 1.4 | 4 | 16V | BBZ |  | 74/101 | 11/03→ | BAE408AE | 15.0 | 30 | 52 |

**POLO Saloon (6KV2)**

|            |   |     |                         |   |        |             |          |     |    |    |
|------------|---|-----|-------------------------|---|--------|-------------|----------|-----|----|----|
| 60 1.4     | 4 | 8V  | AEX, AKV, ANW, ANX, APQ | ✓ | 44/60  | 12/95→09/01 | BAE851AE | 6.5 | 28 | 85 |
| 60 1.4     | 4 | 8V  | AKK, AUD                |   | 44/60  | 12/95→09/01 | BAE907AE | 7.5 | 33 | 85 |
| 75 1.4 16V | 4 | 16V | APE, AUA                |   | 55/75  | 10/99→09/01 | BAE907AE | 7.5 | 33 | 85 |
| 75 1.6     | 4 | 8V  | 1F                      | ✓ | 55/75  | 11/95→09/97 | BAE851AE | 6.5 | 28 | 85 |
| 75 1.6     | 4 | 8V  | AEE                     | ✓ | 55/75  | 11/95→09/01 | BAE851AE | 6.5 | 28 | 85 |
| 100 1.6    | 4 | 8V  | AEH, AFT, AKL, APF, AUR | ✓ | 74/101 | 12/95→09/01 | BAE851AE | 6.5 | 28 | 85 |

**POLO Variant (6KV5)**

|         |   |     |                              |   |        |             |          |     |    |    |
|---------|---|-----|------------------------------|---|--------|-------------|----------|-----|----|----|
| 1.4     | 4 |     | AKP                          |   | 40/54  | 12/98→09/01 | BAE907AE | 7.5 | 33 | 85 |
| 1.4     | 4 | 8V  | AEX, AKV, ANW, ANX, APQ, AUD | ✓ | 44/60  | 05/97→09/01 | BAE851AE | 6.5 | 28 | 85 |
| 1.4     | 4 | 8V  | AKK                          |   | 44/60  | 05/97→09/01 | BAE907AE | 7.5 | 33 | 85 |
| 1.4 16V | 4 | 16V | APE, AUA                     |   | 55/75  | 10/99→09/01 | BAE907AE | 7.5 | 33 | 85 |
| 1.6     | 4 | 8V  | AEE, ALM                     | ✓ | 55/75  | 05/97→09/01 | BAE851AE | 6.5 | 28 | 85 |
| 1.6     | 4 | 8V  | AEH, AFT, AKL, APF, AUR      |   | 74/101 | 05/97→09/01 | BAE907AE | 7.5 | 33 | 85 |

**SHARAN (7M8, 7M9, 7M6)**

|                |   |     |          |   |         |             |          |     |    |    |
|----------------|---|-----|----------|---|---------|-------------|----------|-----|----|----|
| 2.0            | 4 | 8V  | ADY      | ✓ | 85/115  | 09/95→      | BAE851AE | 6.5 | 28 | 85 |
| 2.8 VR6        | 6 | 12V | AAA, AMY | ✓ | 128/174 | 09/95→04/00 | BAE851AE | 6.5 | 28 | 85 |
| 2.8 VR6 Syncro | 6 | 12V | AAA, AMY | ✓ | 128/174 | 11/96→04/00 | BAE851AE | 6.5 | 28 | 85 |

**TOURAN**

|         |   |    |               |  |        |        |          |      |    |    |
|---------|---|----|---------------|--|--------|--------|----------|------|----|----|
| 1.6     | 4 | 8V | BGU, BSE, BSF |  | 75/102 | 07/03→ | BAE907AE | 7.5  | 33 | 85 |
| 1.6 FSI | 4 |    | BAG, BLF, BLP |  | 85/115 | 02/03→ | BAE408AE | 15.0 | 30 | 52 |

**VENTO (1H2)**

|     |   |    |                   |   |        |             |          |     |    |    |
|-----|---|----|-------------------|---|--------|-------------|----------|-----|----|----|
| 1.4 | 4 |    | ABD, AEX          | ✓ | 40/54  | 11/91→09/98 | BAE851AE | 6.5 | 28 | 85 |
| 1.4 | 4 | 8V | ABD, AEX          | ✓ | 44/60  | 11/91→09/98 | BAE851AE | 6.5 | 28 | 85 |
| 1.6 | 4 | 8V | AEK               | ✓ | 74/101 | 10/94→09/98 | BAE851AE | 6.5 | 28 | 85 |
| 1.8 | 4 | 8V | AAM               | ✓ | 55/75  | 11/91→09/98 | BAE851AE | 6.5 | 28 | 85 |
| 1.8 | 4 | 8V | ABS, ADZ          | ✓ | 66/90  | 11/91→09/98 | BAE851AE | 6.5 | 28 | 85 |
| 2.0 | 4 | 8V | 2E, ADY, AGG, AKR | ✓ | 85/115 | 11/91→09/98 | BAE851AE | 6.5 | 28 | 85 |





**VOLKSWAGEN**

**CADDY Mk II (9K9A)**

|        |   |     |          |   |       |             |          |     |    |    |
|--------|---|-----|----------|---|-------|-------------|----------|-----|----|----|
| 1.4    | 4 | 16V | AUA      |   | 55/75 | 08/00→01/04 | BAE907AE | 7.5 | 33 | 85 |
| 60 1.4 | 4 | 8V  | AEX, APQ | ✓ | 44/60 | 11/95→01/04 | BAE851AE | 6.5 | 28 | 85 |
| 60 1.4 | 4 | 8V  | AUD      |   | 44/60 | 11/95→01/04 | BAE907AE | 7.5 | 33 | 85 |
| 75 1.6 | 4 | 8V  | 1F       | ✓ | 55/75 | 11/95→05/97 | BAE851AE | 6.5 | 28 | 85 |















**CADDY III Box (2KA)**

|     |   |  |     |  |       |        |          |      |    |    |
|-----|---|--|-----|--|-------|--------|----------|------|----|----|
| 1.4 | 4 |  | BCA |  | 55/75 | 03/04→ | BAE408AE | 15.0 | 30 | 52 |
|-----|---|--|-----|--|-------|--------|----------|------|----|----|

|                      |   |     |                    |   |                   |  | Amp | Out kV | Out mJ |
|--|---|-----|--------------------|---|-------------------|---|-----|--------|--------|
| <b>...VOLKSWAGEN</b>  |   |     |                    |   |                   |   |     |        |        |
| <b>POLO Fox (6NF)</b>  |   |     |                    |   |                   |   |     |        |        |
| 1.4  | 4 | 8V  | AEX, APQ           | ✓ | 44/60 05/98→      | BAE851AE  | 6.5 | 28     | 85     |
| <b>POLO Fox (86CF)</b>   |   |     |                    |   |                   |   |     |        |        |
| 1.0  | 4 | 8V  | AAU                | ✓ | 33/45 04/93→      | BAE851AE  | 6.5 | 28     | 85     |
| <b>TRANSPORTER Mk IV Box (70XA)</b>  |   |     |                    |   |                   |   |     |        |        |
| 2.0  | 4 | 8V  | AAC                | ✓ | 62/84 07/90→      | BAE851AE  | 6.5 | 28     | 85     |
| 2.5  | 5 | 10V | AAF, ACU, AEN, AEU | ✓ | 81/110 11/90→     | BAE851AE  | 6.5 | 28     | 85     |
| 2.5  | 5 | 10V | AET, APL, AVT      | ✓ | 85/115 08/96→     | BAE851AE  | 6.5 | 28     | 85     |
| 2.5 Syncro   | 5 | 10V | AAF, ACU, AEN, AEU | ✓ | 81/110 10/92→     | BAE851AE  | 6.5 | 28     | 85     |
| 2.5 Syncro   | 5 | 10V | AET, APL, AVT      | ✓ | 85/115 08/96→     | BAE851AE  | 6.5 | 28     | 85     |
| <b>TRANSPORTER Mk IV Bus (70XB, 70XC, 7DB, 7DW)</b>  |   |     |                    |   |                   |   |     |        |        |
| 1.8  | 4 | 8V  | PD                 | ✓ | 49/67 12/90→07/92 | BAE851AE  | 6.5 | 28     | 85     |
| 2.0  | 4 | 8V  | AAC                | ✓ | 62/84 09/90→      | BAE851AE  | 6.5 | 28     | 85     |
| 2.5  | 5 | 10V | AAF, ACU, AEN, AEU | ✓ | 81/110 11/90→     | BAE851AE  | 6.5 | 28     | 85     |
| 2.5 Syncro   | 5 | 10V | AAF, ACU, AEN, AEU | ✓ | 81/110 11/92→     | BAE851AE  | 6.5 | 28     | 85     |
| <b>TRANSPORTER Mk IV Flatbed / Chassis (70XD)</b>  |   |     |                    |   |                   |   |     |        |        |
| 2.0  | 4 | 8V  | AAC                | ✓ | 62/84 07/90→      | BAE851AE  | 6.5 | 28     | 85     |
| 2.5  | 5 | 10V | AAF, ACU, AEN, AEU | ✓ | 81/110 11/90→     | BAE851AE  | 6.5 | 28     | 85     |
| 2.5  | 5 | 10V | AET, APL, AVT      | ✓ | 85/115 08/96→     | BAE851AE  | 6.5 | 28     | 85     |
| 2.5 Syncro   | 5 | 10V | AAF, ACU, AEN, AEU | ✓ | 81/110 10/92→     | BAE851AE  | 6.5 | 28     | 85     |
| 2.5 Syncro   | 5 | 10V | AET, APL, AVT      | ✓ | 85/115 08/96→     | BAE851AE  | 6.5 | 28     | 85     |
| <b>TRANSPORTER Mk V Box (7HA, 7HH)</b>   |   |     |                    |   |                   |   |     |        |        |
| 2.0  | 4 |     | AXA                |   | 85/115 04/03→     | BAE907AE  | 7.5 | 33     | 85     |
| <b>TRANSPORTER Mk V Bus (7HB, 7HJ)</b>   |   |     |                    |   |                   |   |     |        |        |
| 2.0  | 4 |     | AXA                |   | 85/115 04/03→     | BAE907AE  | 7.5 | 33     | 85     |
| <b>TRANSPORTER Mk V Flatbed / Chassis (7JD, 7JE, 7JL)</b>  |   |     |                    |   |                   |   |     |        |        |
| 2.0  | 4 |     | AXA                |   | 85/115 04/03→     | BAE907AE  | 7.5 | 33     | 85     |
| <b>VOLVO</b>        |   |     |                    |   |                   |   |     |        |        |
| <b>460 L (464)</b>   |   |     |                    |   |                   |   |     |        |        |
| 1.8  | 4 | 8V  | B 18 U             |   | 66/90 08/91→07/96 | BAE945A   | 7.5 | 27     | 53     |

VOLVO



|  |  |  |  |  | kW / BHP                          |  |  | Amp      | Out kV | Out mJ |    |
|---|---|---|---|---|-----------------------------------|---|---|----------|--------|--------|----|
| <b>CATERPILLAR</b>  |   |   |   |   |                                   |   |   |          |        |        |    |
| <b>C7</b>   |   |   |   |   |                                   |   |   |          |        |        |    |
| 7.2   | 6   |   |   |   | 250/340                           | 01/07→  | BAE504R   | 8.0      | 28     | 95     |    |
| <b>C9 ACERT</b>   |   |   |   |   |                                   |   |   |          |        |        |    |
| 8.8 ACERT   | 6   |   |   |   | 375/510                           | 01/07→  | BAE5040   | 8.0      | 28     | 95     |    |
| <b>C13</b>  |   |   |   |   |                                   |   |   |          |        |        |    |
| 12.5  | 6   |   |   |   | 400/543                           | 01/07→  | BAE5040   | 8.0      | 28     | 95     |    |
| <b>C15</b>  |   |   |   |   |                                   |   |   |          |        |        |    |
| 15.2  | 6   |   |   |   | 435/591                           | 01/07→  | BAE5040   | 8.0      | 28     | 95     |    |
| <b>LOMBARDINI</b>   |   |   |   |   |                                   |   |   |          |        |        |    |
|   |   |   |   |   | /                                 |   | BAE850AK  | 6.0      | 24     | 40     |    |
|   |   |   |   |   | LOMBARDINI # 0112.001567.199.03.0 | /   | BAE800B   | 6.3      | 25     | 40     |    |
|  |  |  |  |  | kW / BHP                          |  |  | Amp      | Out kV | Out mJ |    |
| <b>BIMOTA</b>   |   |   |   |   |                                   |   |   |          |        |        |    |
| <b>V-Due</b>  |   |   |   |   |                                   |   |   |          |        |        |    |
| 500   |   |   |   |   | BIMOTA # 210.0.003.62             | /   | 01/97→  | BAE850AK | 6.0    | 24     | 40 |
| <b>DUCATI</b>   |   |   |   |   |                                   |   |   |          |        |        |    |
| <b>748, R</b>   |   |   |   |   |                                   |   |   |          |        |        |    |
| 748   |   |   |   |   | DUCATI # 285.4.003.1A             | /   | 01/95→  | BAE850AK | 6.0    | 24     | 40 |
| <b>750, SS</b>  |   |   |   |   |                                   |   |   |          |        |        |    |
| 750   |   |   |   |   | DUCATI # 285.4.003.1A             | /   | 01/94→  | BAE850AK | 6.0    | 24     | 40 |
| <b>851</b>  |   |   |   |   |                                   |   |   |          |        |        |    |
| 851   |   |   |   |   | DUCATI # 285.4.003.1A             | /   | 01/94→  | BAE850AK | 6.0    | 24     | 40 |
| <b>888</b>  |   |   |   |   |                                   |   |   |          |        |        |    |
| 888   |   |   |   |   | DUCATI # 285.4.003.1A             | /   | 01/94→  | BAE850AK | 6.0    | 24     | 40 |
| <b>900, SS</b>  |   |   |   |   |                                   |   |   |          |        |        |    |
| 900   |   |   |   |   | DUCATI # 285.4.003.1A             | /   | 01/94→  | BAE850AK | 6.0    | 24     | 40 |
| <b>907</b>  |   |   |   |   |                                   |   |   |          |        |        |    |
| 907   |   |   |   |   | DUCATI # 285.4.003.1A             | /   | 01/94→  | BAE850AK | 6.0    | 24     | 40 |
| <b>996, SPS</b>   |   |   |   |   |                                   |   |   |          |        |        |    |
| 996   |   |   |   |   | DUCATI # 285.4.003.1A             | /   | 01/97→  | BAE850AK | 6.0    | 24     | 40 |
| <b>998</b>  |   |   |   |   |                                   |   |   |          |        |        |    |
| 998   |   |   |   |   | DUCATI # 285.4.003.1A             | /   | 01/03→  | BAE850AK | 6.0    | 24     | 40 |
| <b>MONSTER 1000S</b>  |   |   |   |   |                                   |   |   |          |        |        |    |
| 1000  |   |   |   |   | DUCATI # 380.4.010.1B             | /   | 01/03→  | BAE800B  | 6.3    | 25     | 40 |
| <b>ST2</b>  |   |   |   |   |                                   |   |   |          |        |        |    |
| 916   |   |   |   |   | DUCATI # 285.4.003.1A             | /   | 01/97→  | BAE850AK | 6.0    | 24     | 40 |
| <b>ST4</b>  |   |   |   |   |                                   |   |   |          |        |        |    |
| 916   |   |   |   |   | DUCATI # 285.4.003.1A             | /   | 01/98→  | BAE850AK | 6.0    | 24     | 40 |
| <b>MOTO GUZZI</b>   |   |   |   |   |                                   |   |   |          |        |        |    |
| <b>BREVA</b>  |   |   |   |   |                                   |   |   |          |        |        |    |
| 877   |   |   |   |   | MOTO GUZZI # 057165300            | /   | 01/06→  | BAE800B  | 6.3    | 25     | 40 |
| <b>CALIFORNIA</b>   |   |   |   |   |                                   |   |   |          |        |        |    |
| 1100  |   |   |   |   |                                   | /   | 01/94→  | BAE850AK | 6.0    | 24     | 40 |
| <b>DAYTONA</b>  |   |   |   |   |                                   |   |   |          |        |        |    |
| 1100  |   |   |   |   |                                   | /   | 01/96→  | BAE850AK | 6.0    | 24     | 40 |
| <b>GRISO</b>  |   |   |   |   |                                   |   |   |          |        |        |    |
| 877   |   |   |   |   | MOTO GUZZI # 057165300            | /   | 01/06→  | BAE800B  | 6.3    | 25     | 40 |
| <b>QUOTA</b>  |   |   |   |   |                                   |   |   |          |        |        |    |
| 1100  |   |   |   |   |                                   | /   | 01/98→  | BAE850AK | 6.0    | 24     | 40 |
| <b>MV AGUSTA</b>  |   |   |   |   |                                   |   |   |          |        |        |    |
| <b>F4, Brutale</b>  |   |   |   |   |                                   |   |   |          |        |        |    |
| 750   |   |   |   |   |                                   | /   | 01/99→  | BAE407A  | 7.5    | 22     | 28 |



**BAE403B**

**FIAT** DOBLO (223)  
DOBLO Cargo (223)  
PALIO Weekend (178DX)  
STILO (192)  
STILO Multi Wagon (192)

**BAE403C**

**ALFA ROMEO** MITO  
**FIAT** 500  
BRAVO  
GRANDE PUNTO (199)  
IDEA  
PANDA (169)  
PUNTO (188)  
STILO (192)  
STILO Multi Wagon (192)  
**LANCIA** MUSA  
YPSILON

**BAE403D**

**FIAT** STILO (192)

**BAE403H**

**LAND ROVER** FREELANDER (LN)  
**MG** MG ZS  
MG ZS Hatchback  
MG ZT  
MG ZT-T  
**ROVER** 45 (RT)  
45 Saloon (RT)  
75 (RJ)  
75 Tourer (RJ)

**BAE407A**

**MV AGUSTA** F4, Brutale

**BAE408AE**

**AUDI** A2 (8Z0)  
A3 (8P1)  
A3 Sportback (8PA)  
**SEAT** CORDOBA (6L2)  
IBIZA IV (6L1)  
LEON (1M1)  
TOLEDO Mk II (1M2)  
**SKODA** FABIA (6Y2)  
FABIA Combi (6Y5)  
FABIA Praktik  
FABIA Saloon (6Y3)  
OCTAVIA (1U2)  
OCTAVIA (1Z3)  
OCTAVIA Combi (1U5)  
OCTAVIA Combi (1Z5)  
ROOMSTER  
**VOLKSWAGEN** BORA (1J2)  
BORA Station wagon (1J6)  
CADDY III Box (2KA)  
CADDY III Station wagon (2KB)  
EOS  
FOX (5Z1)  
GOLF Mk IV (1J1)  
GOLF Mk IV Station wagon (1J5)  
GOLF V (1K1)  
GOLF V PLUS (5M1)  
JETTA III (1K2)  
NEW BEETLE (9C1, 1C1)  
NEW BEETLE Cabriolet (1Y7)  
PASSAT (3C2)  
PASSAT Variant (3C5)  
POLO (9N\_)  
POLO Saloon  
TOURAN

**BAE409A**

- NISSAN** PRIMASTAR Box  
PRIMASTAR Bus
- OPEL** VIVARO Box (F7)  
VIVARO Box  
VIVARO Combi (J7)  
VIVARO Combi
- RENAULT** AVANTIME (DE0\_)  
CLIO III (BR0/1, CR0/1)  
CLIO Mk II (BB0/1/2\_,  
CB0/1/2\_)  
ESPACE Mk III (JE0\_)  
ESPACE Mk IV (JK0/1\_)  
GRAND SCÉNIC (JM0/1\_)  
KANGOO (KC0/1\_)  
KANGOO Express (FC0/1\_)  
LAGUNA (B56\_, 556\_)  
LAGUNA Grandtour (K56\_)  
LAGUNA II (BG0/1\_)  
LAGUNA II Grandtour (KG0/1\_)  
LAGUNA II Sport Tourer (KGO/1\_)  
MEGANE Cabriolet (EA0/1\_)  
MEGANE Classic (LA0/1\_)  
MEGANE Coach (DA0/1\_)  
MEGANE Grandtour (KA0/1\_)  
MEGANE I (BA0/1\_)  
MEGANE II (BM0/1\_, CM0/1\_)  
MEGANE II Coupé-Cabriolet (EM0/1\_)  
MEGANE II Saloon (LM0/1\_)  
MEGANE II Station wagon (KM0/1\_)  
MODUS (F/JPO\_)  
SCÉNIC (JA0/1\_)  
SCÉNIC II (JM0/1\_)  
TRAFIC Box (FL)  
TRAFIC Bus (JL)  
VEL SATIS (BJ0\_)
- VAUXHALL** VIVARO Box  
VIVARO Combi

**BAE504D**

- FIAT** CROMA (154)  
FIORINO Box (146 Uno)  
FIORINO Pick Up (146 Uno)  
REGATA (138)  
TEMPRA (159)  
TEMPRA S.W. (159)  
TIPO (160)  
UNO (146A/E)
- LANCIA** DEDRA (835)  
DELTA Mk II (836)  
THEMA (834)  
Y10 (156)

**BAE504DK****JAGUAR** XJ**BAE504F**

- FIAT** CROMA (154)
- LANCIA** DELTA (831AB0)  
PRISMA (831AB0)
- MASERATI** BITURBO (70, 77)  
BITURBO

**BAE504L**

- RENAULT** 19 Mk II (B/C53\_)  
19 Mk II Saloon (L53\_)  
CLIO I Box (S57\_)  
CLIO I (B/C57\_, 5/357\_)  
TWINGO (C06\_)

**BAE5040**

- CATERPILLAR** C9 ACERT  
C13  
C15



**BAE504R****CATERPILLAR** C7**BAE506D**

**FIAT** PANDA (141A\_)  
TIPO (160)  
UNO (146A/E)  
**LANCIA** Y10 (156)

**BAE506F**

**FIAT** DUNA (146 B)  
DUNA Weekend (146 B)  
FIORINO Box (146 Uno)  
FIORINO Pick Up (146 Uno)  
PANDA (141A\_)  
REGATA (138)  
REGATA Weekend  
RITMO (138A)  
RITMO Mk II (138A)  
UNO (146A/E)  
**LANCIA** DELTA (831AB0)  
THEMA SW (834)

**BAE507AK**

**PEUGEOT** 205 (741A/C)  
309 (10C, 10A)  
309 I (10C, 10A)  
405 (15B)  
405 Estate (15B)

**BAE507BK**

**CITROËN** AX (ZA-\_)  
XM (Y3)  
XM Estate (Y3)  
ZX (N2)  
ZX Estate (N2)  
**PEUGEOT** 106 (1A, 1C)  
605 (6B)

**BAE700AK**

**CITROËN** XANTIA (X1)  
ZX (N2)  
**MASERATI** GHIBLI II  
QUATTROPORTE II  
**PEUGEOT** 306 (7B, N3, N5)  
405 Mk II (4B)

**BAE800B**

**ALFA ROMEO** 33 (907A)  
33 Sport Wagon (907B)  
145 (930)  
146 (930)  
155 (167)  
**DUCATI** MONSTER 1000S  
**FIAT** CINQUECENTO (170)  
COUPE (FA/175)  
DOBLO (223)  
DOBLO Cargo (223)  
PALIO (178BX)  
PALIO Weekend (178DX)  
PANDA (141A\_)  
PANDA (169)  
PANDA Van (141\_)  
PUNTO (176)  
PUNTO (188)  
PUNTO Cabriolet (176C)  
PUNTO Van (176L)  
PUNTO Van (188AX)  
SEICENTO (187)  
SIENA  
STRADA (178E)  
TEMPRA (159)  
TEMPRA S.W. (159)  
TIPO (160)  
**LAMBORGHINI** DIABLO  
**LANCIA** DEDRA (835)  
DEDRA SW (835)  
DELTA (831AB0)  
DELTA Mk II (836)  
THEMA (834)  
THEMA SW (834)  
Y (840A)  
YPSILON  
**LOMBARDINI** ENGINES  
**MOTO GUZZI** BREVA  
GRISO



**BAE801AK**

**RENAULT** ESPACE Mk II (J/S63\_)  
 ESPACE Mk III (JEO\_)  
 LAGUNA (B56\_, 556\_)  
 LAGUNA Estate (K56\_)  
 MEGANE Cabriolet (EA0/1\_)  
 MEGANE Coach (DA0/1\_)  
 MEGANE I (BA0/1\_)  
 MEGANE Scenic (JA0/1\_)

**BAE801BK**

**RENAULT** LAGUNA (B56\_, 556\_)

**BAE801CK**

**RENAULT** ESPACE Mk III (JEO\_)

**BAE801EK**

**RENAULT** ESPACE Mk III (JEO\_)  
 LAGUNA (B56\_, 556\_)  
 MEGANE Classic (LA0/1\_)  
 MEGANE Scenic (JA0/1\_)  
**SEAT** MARBELLA (28)

**BAE850AK**

**BIMOTA** V-Due

**DUCATI** 748, R  
 750, SS  
 851  
 888  
 900, SS  
 907  
 996, SPS  
 998  
 ST2  
 ST4

**LOMBARDINI** ENGINES

**MOTO GUZZI** CALIFORNIA  
 DAYTONA  
 QUOTA

**BAE851AE**

**AUDI** 80 (8C, B4)

80 Avant (8C, B4)  
 100 (4A, C4)  
 100 Avant (4A, C4)  
 A6 (4A, C4)  
 CABRIOLET (8G7, B4)  
 COUPE (89, 8B)

**SEAT** ALHAMBRA (7V8, 7V9)

AROSA (6H)  
 CORDOBA (6K2)  
 CORDOBA (6K2/C2)  
 CORDOBA Vario (6K5)  
 IBIZA Mk II (6K1)  
 IBIZA Mk III (6K1)  
 INCA (6K9)  
 TOLEDO (1L)

**SKODA** FAVORIT (781)

FAVORIT Forman (785)  
 FAVORIT Pickup (787)  
 FELICIA (6U1)  
 FELICIA I (6U1)  
 FELICIA I Fun (797)  
 FELICIA I Station wagon (6U5)  
 FELICIA II (6U1)  
 FELICIA Mk II Station wagon (6U5)  
 FELICIA Pickup (797)  
 FELICIA Station wagon (6U5)  
 OCTAVIA (1U2)  
 OCTAVIA Combi (1U5)

**VOLKSWAGEN** CADDY II Station wagon (9K9B)

CADDY Mk II (9K9A)  
 CORRADO (53I)  
 GOLF Mk II (19E, 1G1)  
 GOLF Mk III (1H1)  
 GOLF Mk III Convertible (1E7)  
 GOLF Mk III Station wagon (1H5)  
 KAEFER  
 PASSAT (3A2, 35I)  
 PASSAT (3A5, 35I)  
 PASSAT Estate (3A2, 35I)  
 PASSAT Variant (3A5, 35I)  
 POLO (6N1)

**...BAE851AE**

**...VOLKSWAGEN** POLO (86C, 80)  
 POLO CLASSIC (86C, 80)  
 POLO Coupe (86C, 80)  
 POLO Fox (6NF)  
 POLO Fox (86CF)  
 POLO Saloon (6KV2)  
 POLO Variant (6KV5)  
 SHARAN (7M8, 7M9, 7M6)  
 TRANSPORTER Mk IV Box (70XA)  
 TRANSPORTER Mk IV Bus (70XB,  
 70XC, 7DB, 7DW)  
 TRANSPORTER Mk IV Flatbed /  
 Chassis (70XD)  
 VENTO (1H2)

**BAE907AE**

**AUDI** A2 (8Z0)  
 A3 (8L1)  
 A3 (8P1)  
 A3 Sportback (8PA)  
 A4 (8D2, B5)  
 A4 (8E2, B6)  
 A4 (8EC)  
 A4 Avant (8D5, B5)  
 A4 Avant (8E5, B6)  
 A4 Avant (8ED)

**FORD** GALAXY (WGR)

**SEAT** ALHAMBRA (7V8, 7V9)  
 ALTEA (5P1)  
 AROSA (6H)  
 CORDOBA (6K2)  
 CORDOBA (6L2)  
 CORDOBA Vario (6K5)  
 IBIZA IV (6L1)  
 IBIZA Mk III (6K1)  
 INCA (6K9)  
 LEON (1M1)  
 TOLEDO III (5P2)  
 TOLEDO Mk II (1M2)

**SKODA** FABIA (6Y2)  
 FABIA Combi (6Y5)  
 FABIA Saloon (6Y3)  
 OCTAVIA (1U2)  
 OCTAVIA (1Z3)  
 OCTAVIA Combi (1U5)  
 OCTAVIA Combi (1Z5)  
 SUPERB (3U4)

**VOLKSWAGEN** BORA (1J2)  
 BORA Station wagon (1J6)  
 CADDY II Station wagon (9K9B)  
 CADDY Mk II (9K9A)  
 FOX (5Z1)  
 GOLF Mk IV (1J1)  
 GOLF Mk IV Station wagon (1J5)  
 GOLF V (1K1)  
 LUPO (6X1, 6E1)  
 MULTIVAN Mk V (7HM)  
 NEW BEETLE (9C1, 1C1)  
 NEW BEETLE Convertible (1Y7)  
 PASSAT (3B2)  
 PASSAT (3B3)  
 PASSAT Variant (3B5)

**...BAE907AE**

**...VOLKSWAGEN** PASSAT Variant (3B6)  
 POLO (6N1)  
 POLO (6N2)  
 POLO (9N\_)  
 POLO Saloon (6KV2)  
 POLO Variant (6KV5)  
 TOURAN  
 TRANSPORTER Mk V Box (7HA, 7HH)  
 TRANSPORTER Mk V Bus (7HB, 7HJ)  
 TRANSPORTER Mk V Flatbed /  
 Chassis (7JD, 7JE, 7JL)

**BAE920AX**

**FIAT** BRAVA (182)  
 BRAVO (182)  
 MAREA (185)  
 MAREA Weekend (185)  
 MULTIPLA (186)  
 PALIO (178BX)  
 PALIO Weekend (178DX)  
 SIENA

**LANCIA** DEDRA (835)  
 DELTA Mk II (836)  
 LYBRA (839AX)  
 LYBRA SW (839BX)

**BAE940A**

**FIAT** 500  
 DOBLO (223)  
 DOBLO Cargo (223)  
 GRANDE PUNTO (199)  
 IDEA  
 SIENA

**LANCIA** MUSA

**BAE945A**

- CITROËN** AX (ZA-\_)  
 BERLINGO (MF)  
 BERLINGO Box (M\_)  
 SAXO (S0, S1)  
 XSARA (N1)  
 XSARA Break (N2)  
 XSARA Coupe (N0)
- PEUGEOT** 106 Mk II (1)  
 206 (2A/C)  
 306 (7B, N3, N5)  
 306 Break (7E, N3, N5)  
 306 Convertible (7D, N3, N5)  
 306 Hatchback (7A, 7C, N3, N5)  
 307 SW (3H)  
 406 (8B)  
 PARTNER Box (5)  
 PARTNER Combispace (5F)
- VOLVO** 460 L (464)

**BAE946A**

- CITROËN** BERLINGO (MF)  
 BERLINGO Box (M\_)  
 C2  
 C3  
 C3 Pluriel  
 SAXO (S0, S1)  
 XSARA (N1)  
 XSARA Break (N2)  
 XSARA Coupe (N0)  
 XSARA PICASSO (N68)
- PEUGEOT** 106 Mk II (1)  
 206 (2A/C)  
 206 SW (2E/K)  
 306 (7B, N3, N5)  
 306 Break (7E, N3, N5)  
 306 Convertible (7D, N3, N5)  
 306 Hatchback (7A, 7C, N3, N5)  
 307 (3A/C)  
 307 Break (3E)  
 307 CC (3B)  
 307 SW (3H)  
 406 (8B)  
 1007  
 PARTNER Box (5)  
 PARTNER Combispace (5F)

**BAE947A**

- RENAULT** CLIO Mk II (BB0/1/2\_,  
 CB0/1/2\_)  
 KANGOO (KCO/1\_)  
 KANGOO Express (FC0/1\_)  
 TWINGO (CO6\_)

**BAE960AE**

- FORD** FOCUS C-MAX  
**SKODA** FELICIA II (6U1)  
 FELICIA Mk II (6U1)  
 FELICIA Mk II Station wagon (6U5)

**BAE961AE**

- SEAT** AROSA (6H)  
**SKODA** FABIA (6Y2)  
 FABIA Combi (6Y5)  
 FABIA Saloon (6Y3)  
 OCTAVIA (1U2)  
 OCTAVIA (1Z3)  
 OCTAVIA Combi (1U5)
- VOLKSWAGEN** LUPO (6X1, 6E1)

**BAE965A**

- OPEL** ASTRA G Convertible  
 ASTRA G Hatchback (F48\_, F08\_)  
 ASTRA G Saloon (F69\_)  
 ASTRA G Station wagon (F35\_)  
 CORSA C (F08, F68)  
 MERIVA  
 VECTRA B (36\_)  
 VECTRA B Hatchback (38\_)  
 VECTRA B Station wagon (31\_)  
 VECTRA C  
 VECTRA C Estate  
 VECTRA C GTS  
 ZAFIRA (F75\_)
- VAUXHALL** ASTRA Mk IV  
 ASTRA MK IV Convertible  
 ASTRA Mk IV Hatchback  
 ASTRA Mk IV Station wagon  
 CORSA Mk II  
 MERIVA  
 VECTRA  
 VECTRA Hatchback  
 VECTRA Mk II  
 VECTRA Mk II Estate  
 VECTRA Mk II GTS  
 VECTRA Station wagon  
 ZAFIRA



|                              |                                |                                |                             |
|------------------------------|--------------------------------|--------------------------------|-----------------------------|
| <b>ALFA ROMEO</b>            | <b>GENERAL MOTORS</b>          | <b>PEUGEOT</b>                 | <b>VOLKSWAGEN</b>           |
| 60805420 <b>BAE800B</b>      | 19005212 <b>BAE965A</b>        | 5970.45 <b>BAE507BK</b>        | 036905715 <b>BAE408AE</b>   |
| 60809492 <b>BAE800B</b>      |                                | 5970.50 <b>BAE700AK</b>        | 032905106B <b>BAE907AE</b>  |
|                              | <b>JAGUAR</b>                  | 5970.74 <b>BAE945A</b>         | 032905106D <b>BAE907AE</b>  |
| <b>BIMOTA</b>                | DAC4608 <b>BAE504DK</b>        | 96035284 <b>BAE507BK</b>       | 036905100A <b>BAE408AE</b>  |
| 210.0.003.62 <b>BAE850AK</b> |                                | 9753078080 <b>BAE507AK</b>     | 036905100B <b>BAE408AE</b>  |
|                              | <b>LAMBORGHINI</b>             | 5970-79 <b>BAE946A</b>         | 036905100D <b>BAE408AE</b>  |
| <b>CATERPILLAR</b>           | 16004528 <b>BAE800B</b>        |                                | 036905715A <b>BAE408AE</b>  |
| 294-9264 <b>BAE504R</b>      |                                | <b>RENAULT</b>                 | 036905715C <b>BAE408AE</b>  |
| 296-7724 <b>BAE504O</b>      | <b>LANCIA</b>                  | 7700107177 <b>BAE409A</b>      | 036905715E <b>BAE408AE</b>  |
|                              | 7588435 <b>BAE504D</b>         | 7700107269 <b>BAE801AK</b>     | 6N0905104 <b>BAE851AE</b>   |
| <b>CITROEN</b>               | 7663177 <b>BAE506D</b>         | 7700113357 <b>BAE409A</b>      | 867905104 A <b>BAE851AE</b> |
| 9611412080 <b>BAE700AK</b>   |                                | 7700749450 <b>BAE504L</b>      |                             |
| 5970-79 <b>BAE946A</b>       | <b>LAND ROVER</b>              | 7700854306 <b>BAE801AK</b>     |                             |
|                              | NEC000070L <b>BAE403H</b>      | 7700854307 <b>BAE801BK</b>     |                             |
| <b>DUCATI</b>                | NEC000110L <b>BAE403H</b>      | 7700858138 <b>BAE504L</b>      |                             |
| 285.2.015.2A <b>BAE800B</b>  |                                | 7700858320 <b>BAE801CK</b>     |                             |
| 285.4.003.1A <b>BAE850AK</b> | <b>LOMBARDINI</b>              | 7700872265 <b>BAE801AK</b>     |                             |
| 380.4.010.1B <b>BAE800B</b>  | 011200156719030 <b>BAE800B</b> | 7700872692 <b>BAE801BK</b>     |                             |
|                              |                                | 7700872693 <b>BAE801CK</b>     |                             |
| <b>FIAT</b>                  | <b>MASERATI</b>                | 7700875000 <b>BAE409A</b>      |                             |
| 7553120 <b>BAE506F</b>       | 477084200 <b>BAE504F</b>       | 7702218697 <b>BAE504L</b>      |                             |
| 7582152 <b>BAE506D</b>       | 571.08.42.00 <b>BAE700AK</b>   | 8200084401 <b>BAE947A</b>      |                             |
| 7588435 <b>BAE506F</b>       |                                | 8200154186 <b>BAE409A</b>      |                             |
| 7646974 <b>BAE506F</b>       | <b>MOTO GUZZI</b>              | 8200208611 <b>BAE409A</b>      |                             |
| 7646975 <b>BAE504F</b>       | BAE800BG <b>BAE800B</b>        | 8200380267 <b>BAE409A</b>      |                             |
| 7663177 <b>BAE506D</b>       |                                | 8200405098 <b>BAE409A</b>      |                             |
| 7672018 <b>BAE800B</b>       | <b>MV AGUSTA</b>               | 8200568671 <b>BAE409A</b>      |                             |
| 7698431 <b>BAE506D</b>       | 8000 99813 <b>BAE407A</b>      | 2526180A <b>BAE409A</b>        |                             |
| 7746151 <b>BAE504D</b>       |                                | 7700113357A <b>BAE409A</b>     |                             |
| 7746152 <b>BAE506D</b>       | <b>NISSAN</b>                  | 7700749450-D <b>BAE504L</b>    |                             |
| 7746153 <b>BAE506F</b>       | 22448-00QAA <b>BAE409A</b>     | 8200154186A <b>BAE409A</b>     |                             |
| 7746154 <b>BAE506D</b>       | 22448-6N011 <b>BAE409A</b>     |                                |                             |
| 7753777 <b>BAE504F</b>       |                                | <b>ROVER</b>                   |                             |
| 7789346 <b>BAE920AX</b>      | <b>OPEL</b>                    | NEC000070 <b>BAE403H</b>       |                             |
| 46446039 <b>BAE920AX</b>     | 1208307 <b>BAE965A</b>         | NEC000110 <b>BAE403H</b>       |                             |
| 46472440 <b>BAE920AX</b>     | 91159996 <b>BAE409A</b>        |                                |                             |
| 46480361 <b>BAE920AX</b>     | 4408 389 <b>BAE409A</b>        | <b>SEAT</b>                    |                             |
| 46543562 <b>BAE800B</b>      | 4413 233 <b>BAE409A</b>        | SE 028915.000B <b>BAE801EK</b> |                             |
| 46548037 <b>BAE800B</b>      |                                |                                |                             |
| 46777286 <b>BAE403B</b>      |                                | <b>SKODA</b>                   |                             |
| 46777287 <b>BAE403D</b>      |                                | 004 050 016 <b>BAE851AE</b>    |                             |
| 46777288 <b>BAE403C</b>      |                                | 032 905 106 <b>BAE907AE</b>    |                             |
| 46790073 <b>BAE800B</b>      |                                | 032 905 106B <b>BAE907AE</b>   |                             |
| 55200112 <b>BAE940A</b>      |                                | 032 905 100A <b>BAE408AE</b>   |                             |
| 55200486 <b>BAE940A</b>      |                                | 032 905 100B <b>BAE408AE</b>   |                             |
| 60815150 <b>BAE800B</b>      |                                | 032 905 100C <b>BAE408AE</b>   |                             |
|                              |                                | 032 905 100D <b>BAE408AE</b>   |                             |
| <b>FORD</b>                  |                                | 032 905 715 <b>BAE408AE</b>    |                             |
| 7053859 <b>BAE907AE</b>      |                                | 032 905 715A <b>BAE408AE</b>   |                             |
| 95WF12029BA <b>BAE907AE</b>  |                                | 032 905 715C <b>BAE408AE</b>   |                             |
|                              |                                | 032 905 715E <b>BAE408AE</b>   |                             |
|                              |                                | 357 905 104 <b>BAE851AE</b>    |                             |
|                              |                                | 6N0905104 <b>BAE851AE</b>      |                             |
|                              |                                | 867 905 104 <b>BAE851AE</b>    |                             |
|                              |                                | 867 905 104A <b>BAE851AE</b>   |                             |
|                              |                                | 047905104 <b>BAE960AE</b>      |                             |
|                              |                                | 047905104A <b>BAE961AE</b>     |                             |



| <b>BERU</b>      |          | <b>BRECAV</b>         |          | <b>MARELLI</b>        |          | <b>STANDARD</b> |          |
|------------------|----------|-----------------------|----------|-----------------------|----------|-----------------|----------|
| 0010100249       | BAE507BK | 106.001               | BAE403B  | 060705404010          | BAE504D  | 12304           | BAE507BK |
| 0040100029       | BAE920AX | 106.002               | BAE403C  | 060705406010          | BAE504F  | 12601           | BAE506D  |
| 0040100052       | BAE409A  | 106.007               | BAE403D  | 060705446010          | BAE504DK | 12605           | BAE506F  |
| 0040100068       | BAE403H  | 109.001               | BAE965A  | 060705604010          | BAE506D  | 12619           | BAE800B  |
| 0040100244       | BAE506D  | 110.004               | BAE700AK | 060705606010          | BAE506F  | 12620           | BAE504D  |
| 0040100248       | BAE506F  | 114.003               | BAE961AE | 060705607010          | BAE506D  | 12646           | BAE801EK |
| 0040100250       | BAE504L  | 124.001               | BAE960AE | 060705754010          | BAE507BK | 12662           | BAE504L  |
| 0040100259       | BAE965A  |                       |          | 060707038010          | BAE700AK | 12679           | BAE801AK |
| 0040100283       | BAE800B  |                       |          | 060708049002          | BAE801EK | 12680           | BAE801BK |
| 0040100315       | BAE801EK |                       |          | 060708138010          | BAE801AK | 12681           | BAE801CK |
| 0040100317       | BAE801AK | <b>CHAMPION (OLD)</b> |          | 060708149010          | BAE801AK | 12700           | BAE920AX |
| 0040100318       | BAE801BK | AMC504D               | BAE504D  | 060708149010          | BAE801EK | 12711           | BAE409A  |
| 0040100319       | BAE801CK | AMC504F               | BAE504F  | 060740302010          | BAE403B  | 12737           | BAE403B  |
| 0040100320       | BAE403B  | AMC504L               | BAE504L  | 060740303010          | BAE403C  |                 |          |
| 0040100321       | BAE403D  | AMC506D               | BAE506D  | 060740304010          | BAE403D  |                 |          |
| 0040100322       | BAE403C  | AMC506F               | BAE506F  | 060780002010          | BAE800B  | <b>TESLA</b>    |          |
| 0040100323       | BAE700AK | AMC507AK              | BAE507AK | 060780003010          | BAE800B  | CL001           | BAE851AE |
| 0040100330       | BAE506D  | AMC700AK              | BAE700AK | 060792001010          | BAE920AX | CL002           | BAE907AE |
| 0040102030       | BAE408AE | AMC800B               | BAE800B  | 060796105010          | BAE961AE | CL003           | BAE408AE |
| 0040402001       | BAE851AE | AMC920AX              | BAE920AX | 060801008010          | BAE965A  | CL007           | BAE961AE |
| 0040402003       | BAE907AE |                       |          | 060885038002          | BAE850AK | CL008           | BAE960AE |
| ZS029            | BAE920AX |                       |          | BAE506G               | BAE506D  |                 |          |
| ZS052            | BAE409A  | <b>ERA</b>            |          | BAE800AK              | BAE800B  |                 |          |
| ZS068            | BAE403H  | 880001                | BAE851AE | BAE800BAM             | BAE800B  |                 |          |
| ZS079            | BAE940A  | 880003                | BAE907AE | BAE800EK              | BAE801EK |                 |          |
| ZS244            | BAE506D  | 880006                | BAE408AE |                       |          |                 |          |
| ZS248            | BAE506F  | 880008                | BAE800B  | <b>MEAT&amp;DORIA</b> |          |                 |          |
| ZS249            | BAE507BK | 880009                | BAE409A  | 10300                 | BAE409A  |                 |          |
| ZS250            | BAE504L  | 880027                | BAE504L  | 10302                 | BAE800B  |                 |          |
| ZS259            | BAE965A  | 880033                | BAE961AE | 10303                 | BAE920AX |                 |          |
| ZS283            | BAE800B  | 880034                | BAE945A  | 10304                 | BAE506F  |                 |          |
| ZS315            | BAE801EK | 880035                | BAE946A  | 10305                 | BAE506D  |                 |          |
| ZS317            | BAE801AK | 880036                | BAE947A  | 10307                 | BAE907AE |                 |          |
| ZS318            | BAE801BK | 880038                | BAE403B  | 10308                 | BAE851AE |                 |          |
| ZS319            | BAE801CK | 880039                | BAE965A  | 10309                 | BAE504F  |                 |          |
| ZS320            | BAE403B  | 880067                | BAE403H  | 10315                 | BAE965A  |                 |          |
| ZS321            | BAE403D  | 880068                | BAE403C  | 10323                 | BAE945A  |                 |          |
| ZS322            | BAE403C  | 880069                | BAE504DK | 10324                 | BAE946A  |                 |          |
| ZS323            | BAE700AK | 880089                | BAE700AK | 10325                 | BAE947A  |                 |          |
| ZSE001           | BAE851AE |                       |          | 10329                 | BAE408AE |                 |          |
| ZSE003           | BAE907AE |                       |          | 10333                 | BAE961AE |                 |          |
| ZSE030           | BAE408AE |                       |          | 10339                 | BAE403D  |                 |          |
|                  |          | <b>FACET</b>          |          | 10340                 | BAE700AK |                 |          |
| <b>BOSCH</b>     |          | 9.6008                | BAE506D  | 10354                 | BAE801EK |                 |          |
| 0221603010       | BAE907AE | 9.6046                | BAE800B  | 10389                 | BAE403H  |                 |          |
| 0986221000       | BAE851AE | 9.6048                | BAE504D  | 10394                 | BAE960AE |                 |          |
| 0986221001       | BAE409A  | 9.6055                | BAE507BK |                       |          |                 |          |
| 0986221023       | BAE408AE | 9.6058                | BAE506F  |                       |          |                 |          |
| 0986221029       | BAE507BK | 9.6096                | BAE801EK |                       |          |                 |          |
| 0986221034       | BAE945A  | 9.6128                | BAE504L  |                       |          |                 |          |
| 0986221035       | BAE946A  | 9.6175                | BAE801AK |                       |          |                 |          |
| 0986221036       | BAE947A  | 9.6176                | BAE801BK | <b>SIDRA</b>          |          |                 |          |
|                  |          | 9.6177                | BAE801CK | 60705604              | BAE506D  |                 |          |
|                  |          | 9.6242                | BAE504DK | BBN0250               | BAE504L  |                 |          |
|                  |          | 9.6245                | BAE920AX | BBN0283               | BAE800B  |                 |          |
|                  |          | 9.6319                | BAE947A  |                       |          |                 |          |
|                  |          | 9.8114                | BAE851AE |                       |          |                 |          |
|                  |          | 9.8120                | BAE907AE |                       |          |                 |          |
|                  |          | 9.6303S               | BAE945A  |                       |          |                 |          |
| <b>BOUGICORD</b> |          |                       |          |                       |          |                 |          |
| 151401           | BAE947A  |                       |          |                       |          |                 |          |
| 155026           | BAE851AE |                       |          |                       |          |                 |          |
| 156100           | BAE907AE |                       |          |                       |          |                 |          |
| 156200           | BAE409A  |                       |          |                       |          |                 |          |
| 156300           | BAE965A  |                       |          |                       |          |                 |          |
| 156600           | BAE700AK |                       |          |                       |          |                 |          |
| 15430100001      | BAE945A  |                       |          |                       |          |                 |          |
| 15430200001      | BAE946A  |                       |          |                       |          |                 |          |

**Federal-Mogul Corporation  
Central Distribution Centre**

Prins Boudewijnlaan 7 • B-2550 Kontich • Belgium  
Phone +32 (0) 3450 8310 • Fax +32 (0) 3450 8338



**Federal-Mogul Italy Srl  
Aftermarket Division**

Via Enrico Fermi 8 • 37135 Verona • Italy  
Phone +39 045 828 13 11 • Fax +39 045 828 14 00



**Federal-Mogul Friction Products GmbH  
Federal-Mogul Aftermarket**

Klosterstraße 16 • D-51709 Marienheide • Germany  
Phone +49 (0) 2264-89 0 • Fax +49 (0) 2264-89 270



**Federal-Mogul Aftermarket UK Limited**

Greyhound Drive • Bradford • BD7 1NQ • England  
Phone +44 (0) 1274 723481 • Fax +44 (0) 1274 848282



**Federal-Mogul Ibérica S.L.**

Avda.1ª del Parc Logístic, no 5 - 7 • Políg. Zona Franca • 08040 Barcelona • Spain  
Phone +34 902 33 76 36 • Fax +34 902 21 31 23



**Federal-Mogul Aftermarket España S.A.**

Mario Roso de Luna, 41. Nave 6 • Polígono Fin de Semana • 28022 Madrid • Spain  
Phone +34 91 746 1900 • Fax +34 91 746 1890



**Federal-Mogul Aftermarket France**

60-62, rue Danjou • 92517 Boulogne-Billancourt Cedex • France  
Phone +33 (0) 1 46 94 27 00 • Fax +33 (0) 1 46 94 27 01  
**Service Commande:**  
Phone +33 (0) 810 000 29 • Fax +32 (0) 345 080 26



**Federal-Mogul Aftermarket  
Southern Africa (PTY) Ltd**

33 Western Boulevard • City West • Johannesburg • South Africa  
Phone +27 11 630 3000 • Fax +27 11 630 3212



**Federal-Mogul Aftermarket Turkey**

Meclisi, Mebusan Caddesi, No: 133 • Findikli - Istanbul 80040 • Turkey  
Phone +90 212 292 6313 • Fax +90 212 292 6260





 **FEDERAL  
MOGUL**



CATCM901

 [www.fmecat.eu](http://www.fmecat.eu)